



www.dtco.vdo.com

Digital Tachograph – DTCO[®] 1381

Release 2.0 – 2.1

Operating instructions Company & Driver 



VDO

Dear user,

The **DTCO 1381** digital tachograph, with its system components, is an EC recording device that complies with the technical specifications according to the EC regulation (EEC) no. 3821/85 annex I B, (as amended).

The prepared data helps ...

- the driver obey the law when driving
- and gives the company useful data about the performance of the driver and the vehicle (special software required).



These operating instructions were written for the **company** and the **drivers** and describe proper handling of the DTCO 1381 as specified by the regulations. Carefully read these instructions and become familiar with the DTCO 1381.

Further information on the DTCO 1381 as well as contact addresses are available on the Internet at: **www.dtco.vdo.com**

We wish you happy motoring.

Your friends at Continental Automotive GmbH

© 04.13 by Continental Automotive GmbH

Responsible for content:

Continental Automotive GmbH
P.O. Box 1640
78006 Villingen-Schwenningen
GERMANY

We reserve the right to make changes to technical details in the descriptions, specifications, and figures contained in these operating instructions. Reprinting, translations, and reproductions are not permitted without written approval.

Release overview	6	Display of messages	19	Continuing the work shift	33
General instructions	1	Production status	19	Continuing the work shift and prefixing activities to a work shift	34
Means of depiction	8	Out of scope	19	Setting activities	35
Handling the DTCO 1381	9	Ferry transfer or train transfer	19	Manual setting	35
Legal requirements	10	Behaviour during low voltage / overvoltage	20	Automatic setting	35
Obligations of the driver	10	Power interruption	20	Automatic setting after ignition on/off *	35
Obligations of the company	11	"Company" mode	3	Handwritten activity entries	36
Handling of the printouts	11	Functions of the company card	22	Downloading driver card data	37
Handling the tachograph cards	12	Menu functions in the "company" mode	22	Withdrawing driver card(s)	38
Cleaning tachograph card	12	Company card insertion	23	Menu guidance after withdrawing driver card	39
Introduction	2	Enter vehicle registration number ...	24	Driver / vehicle change during operation	41
First operating steps	14	Prepare data download	25	Documents to be kept while driving ..	42
For the company	14	Company card withdrawal	26	Printer Handling	5
For the driver	14	Operational mode	4	Insert paper roll	44
Display and operational elements ...	15	Inserting driver card(s)	28	Printout of data	45
Brief description	15	Manual entries	28	Start printout	45
Display variations	17	Correction possibilities	30	Cancel printout.....	45
Standby mode	17	Country entry during manual entry ..	31	Things to note when printing	46
VDO GeoLoc * (from Release 2.1) ..	17	Aborting the entry procedure.....	31	Clear paper jam	46
Display after ignition on/off	17	Add "Rest period" activity	32		
Standard display(s)	18				
Data display when the vehicle is stationary	18				

Table of contents



Menu functions 6	Main menu, vehicle printout 58	Overview of the faults 70
Calling up menu functions 48	Print daily value from	Driving time warnings 72
When the vehicle is stationary 48	the data memory 58	VDO Counter * display 72
Change of activities 48	Print events from the data memory .. 58	Overview of the operational notes ... 73
Display at start of drive 48	Print instances of over-speeding 58	
Displaying the times of the	Print technical data 58	
driver card 49	Print v-diagram 59	
Setting the language 49	Print D1/D2 status * 59	
VDO Counter * 50	Print speed profiles * 59	
Layout of the VDO Counter display .. 50	Print rpm profiles * 59	
Displays during trip 51	Main menu entry driver 1 / driver 2 .. 60	
Display for activity "Break time" 52	Enter Begin country 60	
Display for activity "Working time" ... 52	Enter End country 60	
Display daily values 53	Main menu entry vehicle 61	
Display weekly values 53	Enter Out beginning / end 61	
Status display 53	Enter Beginning of ferry / train 61	
Overview of the menu structure 54	Set Local time 61	
Navigating in the menu functions ... 55	Make UTC correction 62	
Menu access blocked! 56	Main menu display driver 1 /	
Leaving menu functions 56	driver 2 63	
Main menu printout driver 1 /	Main menu display vehicle 64	
driver 2 57		
Print daily value 57	Messages 7	
Print events 57	A message appears 66	
Print activities..... 57	Characteristics of the messages 66	
	Acknowledgement of messages..... 67	
	Overview of the events 68	

Care and maintenance.....	83	Speed profiles *	97
Cleaning the DTCO 1381	83	Rpm profiles *	97
Compulsory Tachograph		Printout in local time	97
inspections	83	Explanations of printout examples ..	98
Behaviour when repairing /		Legend of the data blocks	98
replacing the DTCO 1381	83	Data record purpose during	
Disposal of the components	83	events or faults	105
Technical data	84	Coding of data record purpose	105
DTCO 1381	84	Coding for more detailed	
Paper roll	84	description	107
Pictograms and printout		Appendix	A
samples	9	<hr/>	
Overview of the pictograms	86	Keyword directory	109
Pictogram combinations	87	Automatic setting of the activities	
Country symbols.....	89	after ignition on/off	112
Symbols of the regions	90	Notes.....	113
Printout examples.....	91	EC Declaration of Conformity	115
Daily printout from the driver card ...	91		
Events / faults from the driver card..	92		
Daily printout of the vehicle	93		
Events / faults from the vehicle.....	94		
Over-speeding	95		
Technical data	95		
Driver's activities.....	96		
v-diagram.....	96		
Status D1/D2 diagram *	96		

Table of contents

■ Release overview

The present certified operating instructions are valid for the following DTCO 1381 device versions:

Release version (can be seen on the model plate)	Certified operating instructions	Special operational features
 <p>Confederal Automotive GmbH ACC044911 D-78532 VS=Villingen Typ 1381.1... No. NLL... Jahr MJJ 01 01 E 10 R- 03 4031 x xxx xxx xx xxxxx CE 0044 R&S X... Rel. 2.0</p>	BA00.1381.20 101 102	<ul style="list-style-type: none">• During driving, individual setting of a desired standard display possible.• Printout in local time possible.
 <p>Confederal Automotive GmbH ACC044911 D-78532 VS=Villingen Typ 1381.1... No. NLL... Jahr MJJ 01 01 E 10 R- 04 4031 x xxx xxx xx xxxxx CE 0044 R&S X... Rel. 2.1</p>	BA00.1381.21 100 102	<p>Current operating instructions</p> <ul style="list-style-type: none">• Change in the menu navigation for driver card insertion; ➔ <i>page 28.</i>• Menu display depending on the inserted cards; ➔ <i>page 48.</i>• VDO GeoLoc: Optional recording of the position data of a vehicle; ➔ <i>page 17.</i>• Information about the due download of a driver card when it is removed; ➔ <i>page 39.</i>

 These operating instructions do not apply for earlier device release versions!

General instructions

Means of depiction

Handling the DTCO 1381

Legal requirements

Handling the tachograph cards

Service Only

1

■ Means of depiction

You will find the following emphases in these operating instructions:



Warning message

A warning message points out possible risks of injury or accidents.



Attention!

The text beside or below this symbol contains important information to avoid loss of data, to prevent damage to the device, and to comply with legal requirements.



Hint

This sign will give you some advice or information which, when not observed, could lead to malfunctions.



The book means a reference to another documentation.

Steps

1. The numbered steps describe actions – You must do something. For example you will be guided through the menu step by step and asked to make an entry.
2. Further actions are numbered consecutively.

Symbols

- * The asterisk marks a special feature / option.
Note: Observe the instructions for the **ADR variant** * "☺" and the option "**Automatic adjustment of the activities after ignition on/off**" *, as individual functions depend on the ignition. The **VDO Counter** * supports your daily, weekly planning when "on the road".
- ➡ This sign shows the page on which you will find further information about the topic.
- ↔ This sign indicates that the topic will be continued on the next page.

Menu representation

```

1 — driver 1
   — besin country
  
```

Flashing lines or characters in the menu display are shown in *italics* (1) in these operating instructions.

Definitions

- Driver 1** = Crewmember who is driving the vehicle at the moment or will be driving the vehicle.
- Driver 2** = Crewmember who is not driving the vehicle.

■ Handling the DTCO 1381



Risk of Accident

While driving, messages can appear in the display. It is also possible that the driver card will be automatically ejected.

Do not be distracted by this; instead, continue to focus all of your attention on driving safely.



Danger of injury

You and other persons might be injured by an open printer drawer. Open the printer drawer only for inserting a paper roll!

Depending on the volume of information printed, the thermal printing head may be very hot! Wait until the printing head has cooled down before you insert a new roll of paper.



Danger of explosion

The DTCO 1381 ADR version * is designed for use in explosion-risk environments.

Please observe the instructions for transport and handling of hazardous materials in explosion-risk environments.



Observe the following instructions in order to avoid damage to the DTCO 1381!

- Authorised persons are responsible for installing and sealing the DTCO 1381. **Do not carry out any repairs of the device or the supply lines.**
- Do not insert any other cards, such as credit cards, cards with relief printing, or metallic cards, etc. into the card slot. These type of cards will damage the card slot of the DTCO 1381!

- Only use type-approved paper rolls recommended by the manufacturer (original VDO printer paper). Make sure that it contains the approval mark. ➔ *Details refer to "Paper roll" on page 84.*
- Do not activate the button elements with sharp-edged or pointed objects such as a ballpoint pen, etc.
- Clean the unit with a slightly moist towel or with a microfibre cleaning cloth. (Available from your sales and service center.) ➔ *Refer to "Care and maintenance" on page 83.*

■ Legal requirements



Any person who makes any changes to tachographs or the signal feed in a way that influences the recording and memory of the tachographs, especially if done with fraudulent intentions, may violate laws or provisions.

The falsification, suppression, or destruction of tachograph recordings, the tachograph cards, and the printed documents is forbidden.

Legal Foundation

The use of tachographs is now regulated in the latest consolidated valid version of the EC regulations 3821/85 in combination with EC regulations (EC) no. 561/2006 and the relevant national laws. They require the driver and the operator of the vehicle (company) to conform to a number of obligations and responsibilities. The following list is not guaranteed to be complete or legally valid.

▶ Obligations of the driver

- The driver must take care that the driver card and the tachograph will be used properly.
- Behaviour in the event of malfunctions of the tachograph:
 - The driver must note information about the activities which are no longer properly recorded or printed by the tachograph on a separate sheet or on the rear side of the paper roll!
 - ➔ Refer to “Handwritten activity entries” on page 36.
 - If away from base, for more than 1 week, the driver must ensure that the tachograph is repaired by an authorised workshop en route.
- During mixed tachograph operation (use of vehicles with analogue [chart based] and digital tachograph), the necessary documents must be carried.
 - ➔ Refer to “Driver / vehicle change during operation” on page 40.
- If the driver card is lost, stolen, damaged, or malfunctions, then the driver must at the beginning and at the end of the journey generate a daily printout from the DTCO 1381 and add his personal information. If necessary, availability periods and other working times must be inserted by handwritten entries.
 - ➔ Refer to “Handwritten activity entries” on page 36.
- If the driver card is damaged or fails to operate properly, it must be sent back to the authorised authority, or its loss must be duly notified. The replacement card must be applied for within seven calendar days.
- If the driver card is lost, stolen, damaged or malfunctions, a journey may be continued without driver card for a period of 15 calendar days or longer if necessary for the vehicle to return to the company location.



- Inform the authorised authority immediately about the exact reasons for the renewal, replacement, or exchange of the driver card by another member state authority.
 - After the end of validity, the driver must continue to carry the driver card for at least 28 calendar days (Driving Personnel Decree in Germany).
- **Obligations of the company**
- Take care that, when a new vehicle is delivered, an authorised workshop immediately completes the calibration data with authorised member state and vehicle registration number.
 - When inserting in the company card, you are requested, if necessary, to enter the member state and the vehicle registration number of the vehicle in the DTCO 1381.
 - Refer to “Enter vehicle registration number” on page 24.
 - Lock the company in the DTCO 1381 at the beginning of the vehicle deployment, and lock it out again at the end.
 - Details refer to “Company card insertion” on page 23.
- Make sure that enough authorised rolls of paper are available in the vehicle.
 - Monitor the proper function of the tachograph. Observe the intervals which, according to the legal stipulations, are prescribed for the inspection of the tachograph. (Periodic (calibration) test at least every two years.)
 - Download the data from the data memory of the DTCO 1381 and from the driver cards at regular intervals and store the data according to the legal stipulations.
 - Have repair and calibration work done by authorised workshops only.
 - Details refer to “Compulsory Tachograph inspections” on page 83.
 - Supervise the proper use of the tachograph by the drivers. Check driving times and rest periods periodically and compare these with the legal requirements.
- **Handling of the printouts**
- Take care that the printouts will not be damaged by strong light, sunlight, moisture, or heat (making them illegible).
 - The holder of the vehicle / the company must retain the legal printouts for at least 1 year. (2 years for Working Time Directive Regulations.)

1 ■ Handling the tachograph cards

Possession of a tachograph card authorises the holder to use the DTCO 1381. Areas of activity and access rights are prescribed by law.

➔ Refer to "Tachograph cards" on page 79.

 The driver card is person-specific. The driver uses this card to identify himself to the DTCO 1381.

The driver card is not transferable!

 The company card is designed for owners and operators of vehicles with installed digital tachograph and must not be transferred to "Others".

The company card must not be used for driving!



Handle your tachograph card carefully in order to avoid loss of data and observe the instructions of the issuing authorities for tachograph cards.

- Do not bend or fold the tachograph card and do not use them for anything other than their intended purpose.
- Do not use damaged tachograph cards.
- Keep all contact surfaces clean, dry, and free of grease and oil (always use a protective cover).
- Protect the card from direct sunlight (do not allow it to lie on the instrument panel).
- Do not place it in direct proximity to strong electromagnetic fields.
- Do not use the card beyond its period of validity. Apply for a new tachograph card in a timely manner before expiry.

► Cleaning tachograph card

Clean dirty contacts of the tachograph card with a slightly moistened cloth or with a microfibre cleaning cloth. (Available from your sales and service center.)



Do not use any solvents like thinner or petroleum spirits to clean the contacts of a tachograph card.

Service only

Introduction

First operating steps

Display and operational elements

Display variations

■ First operating steps

► For the company

- 2** 1. Register your company within the DTCO 1381. Insert the company card into any card slot.
- *Details refer to “Company card insertion” on page 23.*

 The company card must not be used for driving!

2. Withdraw the company card at the end of the registration or the download of data from the card slot.
- *Details refer to “Company card withdrawal” on page 26.*

► For the driver

1. Insert your driver card into the card slot at the beginning of the shift (start of working day).
- *For more details, see “Inserting driver card(s)” from page 28.*
2. Using the "Manual entry" you can add activities on your driver card.
- *For more details, see “Manual entries” from page 28.*

3. Use the activity button to adjust the activity you want to carry out at that moment.
- *Details refer to “Setting activities” on page 35.*

4. Adjust the time to the current local time.
- *Details refer to “Set Local time” on page 61.*

The DTCO 1381 is ready for operation!

5. **Important!** During a rest period or break time, always set the activity to "H".
6. Possible faults in the device or the system components will appear in the display. Acknowledge the message.
- *For more details, see “A message appears” from page 66.*
7. At the end of the shift (end of the working day) or vehicle change, you request your driver card from the card slot.
- *For more details, see “Withdrawing driver card(s)” from page 38.*

8. You can display or print activities from preceding days as well as saved events, etc. by means of the menu functions.

➤ *For more details, see “Calling up menu functions” from page 48.*



These operating instructions do not contain the legal requirements which are valid in the respective countries. If necessary, they must be complied with, too.

■ Display and operational elements

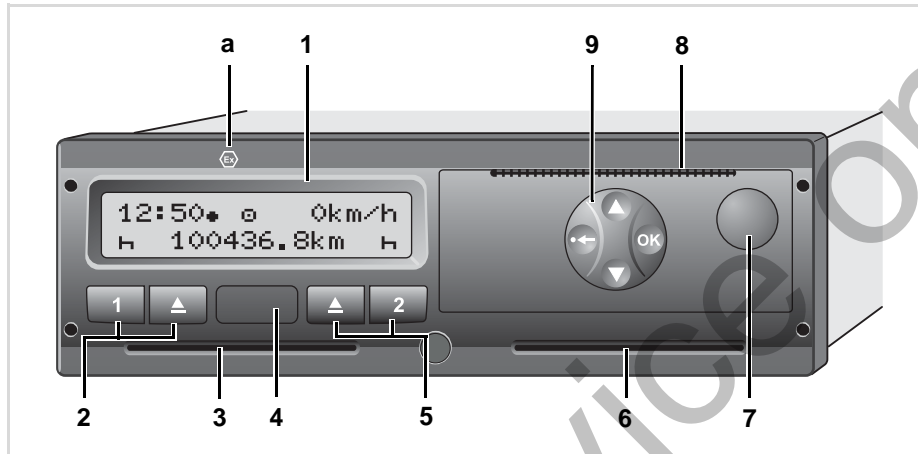

- (1) Display
- (2) Driver 1 keypad
- (3) Card slot 1
- (4) Download interface
- (5) Driver 2 keypad
- (6) Card slot 2
- (7) Unlock button printer drawer
- (8) Cutting edge
- (9) Menu buttons

(a) Symbol "Ⓔ" for ADR variant *
(ADR = European Agreement concerning the international carriage of dangerous goods by road)

The DTCO 1381 can be remotely controlled by the corresponding accessories.

► Brief description

Display (1)

Depending on the vehicle's operational condition, different displays will appear or data can be displayed.

➔ Refer to "Display variations" on page 17.

Driver 1 keypad (2)

- Activity button for driver 1
➔ Details refer to "Setting activities" on page 35.
- ▲ Ejection button for card slot 1

Card slot 1 (3)

Driver 1, who will drive the vehicle at this moment in time, inserts his driver card into slot 1.

➔ For more details, see "Inserting driver card(s)" from page 28.

Download interface (4)

The download interface is located under the cover. The access rights of this interface are regulated according to the inserted tachograph card.

➔ *Details refer to “Access rights of the tachograph cards” on page 80.*

Driver 2 (5) keypad

2 Activity button for driver 2

▲ Ejection button for card slot 2

Card slot 2 (6)

Driver 2, who is not driving the vehicle at this moment in time, inserts his driver card into slot 2 (crew operation).

Unlock button (7)

Use this button to unlock the printer drawer, for example when inserting a roll of paper.

Cutting edge (8)

You can use the cutting edge to tear off a printout generated by the integrated printer.

Menu buttons (9)

Use the following buttons to enter, display, or print out data:

- ▲/▼** Use the paging function to select the desired function or selection. (This is possible by pressing and holding down the auto-repeat function key.)
- OK** Confirm or acknowledge desired function / selection.
- OK** Press and hold, repeatedly until the last entry field.
- ←** Back to the last entry field, abort the entry of a country, or leave the menu one step at a time.

ADR variant * (a)

☞ Some functions, such as insertion or removal of the tachograph cards, printing or display of data are possible only while the ignition is switched on!

☞ The download interface cap on the DTCO 1381 must be closed during loading and unloading of hazardous materials.

Model plate

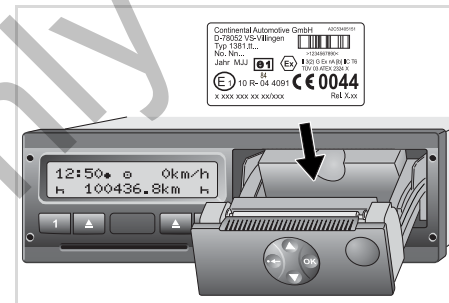

Model plate

After opening the printer drawer, the model plate is visible with the following data: Name and address of the manufacturer, device version, serial number, year of manufacture, test and approval mark, and release version.

From Release 2.1: Following a software upgrade, the hardware and software versions are identified by a sticker located in the printer drawer.

■ Display variations

General Information

The display consists of pictograms and text with the language being automatically set as follows:

- The language will be determined by the driver card that is currently inserted in card slot 1 and / or the driver card that was most recently inserted in the DTCO 1381.
- Or the tachograph card with a higher value, such as the company card, control card.

Select language

As an alternative to the automatic language setting, you can individually set a preferred language.

➔ *Details refer to "Setting the language" on page 49.*

► Standby mode

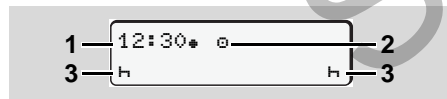

Display Standby mode

In the Operational "a" mode, the DTCO 1381 will switch into standby mode after about 5 minutes:

- the vehicle's ignition is off,
- and no message is pending.

The set activities (3) will appear in addition to the time (1) and operating mode (2). The display disappears after another 3 minutes (customer-specific value).

Display Standby mode will be cancelled when:

- you switch on the ignition
- you press any key,
- or when the DTCO 1381 announces an event or a fault.

► VDO GeoLoc * (from Release 2.1)

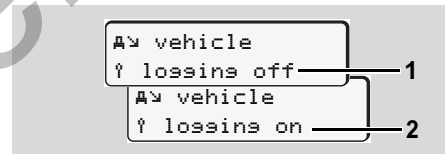

VDO GeoLoc

You have the option of switching the recording of the vehicle position to on (2) or off (1).

► Display after ignition on/off

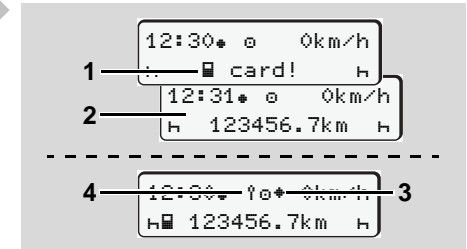

Display after ignition on/off

Ignition on: If there is no tachograph card in card slot 1, this note (1) will appear for approximately 20 seconds and then the standard display (2) will appear.

Ignition off: Symbol (3) indicates that the IMS function is available. (IMS = Independent Motion Signal)

From Release 2.1: Symbol (4) indicates that the VDO GeoLoc function is switched on.

► **Standard display(s)**

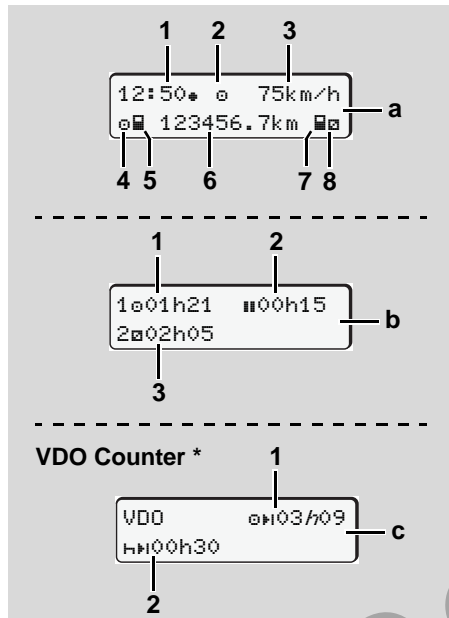

Standard displays during trip

As soon as the vehicle starts moving and no message is displayed, the previously set standard display appears automatically.

By pressing any menu key, you can also switch over to the standard display (a), (b) or (c).

Standard display (a):

- (1) Time
with symbol "*" = Local time
without symbol "*" = UTC time
- (2) Symbol of the operating mode
"Operational"
- (3) Speed
- (4) Activity, driver 1
- (5) Card symbol, driver 1
- (6) Total odometer
- (7) Card symbol, driver 2
- (8) Activity, driver 2

Standard display (b):

- (1) Driving time "e" of Driver 1 since a valid break time.
- (2) Valid break time "00" in cumulative break periods of at least 15 minutes followed by 30 minutes, in accordance with regulation (EU) no. 561/2006.
- (3) Times of driver 2:
Current activity availability time "h" and duration of activity.

☞ If the driver card is missing, times which are assigned to the respective card slot "1" or "2" will appear.

Option: VDO Counter * (c)

- (1) Remaining driving time "e01" ("h" flashes = this part of the display is currently active).
- (2) Next valid break time / daily or weekly rest period "h01".
☞ For more details, see "VDO Counter *" from page 50.

► **Data display when the vehicle is stationary**

When the vehicle is not moving and driver card is inserted, you can call up other data of the driver card.

☞ Refer to "Calling up menu functions" on page 48.

► Display of messages

Regardless of which display currently appears or whether the vehicle is moving or stationary, messages will be displayed with priority.

➔ Refer to "A message appears" on page 66.

► Production status

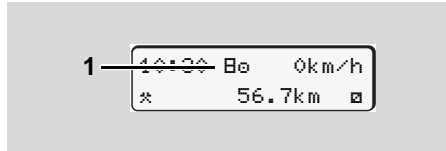

Display of production status

If the DTCO 1381 has not yet been activated as a recording device, then "Production status", symbol "E" (1) will appear. The DTCO 1381 will not accept any tachograph cards except the workshop card.



Please make sure that the DTCO 1381 is immediately and properly brought into operation by an authorised workshop.

► Out of scope

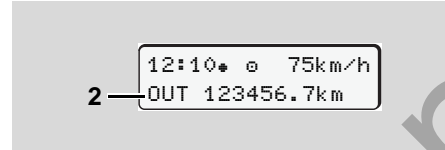

Standard display (a): Out of Scope display

The vehicle is driving outside the scope of the regulations, symbol "OUT" (2).

You can set this function through the menu.

➔ Refer to "Enter Out beginning / end" on page 61.

The following journeys may be outside of the scope of application:

- Journeys on non-public roads.
- Journeys outside of EU countries.
- Journeys where the vehicle does not require use of the DTCO 1381 in accordance with the regulations.

By pressing any menu key, you can switch over to the standard display (b) or (c) *,
➔ see page 18.

► Ferry transfer or train transfer

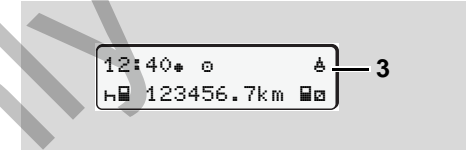

Standard display (a): Display of ferry transfer or train transfer

The vehicle is located on a ferry or on a train, symbol "F" (3).

You can set this function through the menu.

➔ Refer to "Enter Beginning of ferry / train" on page 61.



Please ensure that this function and its current activity are set during the transport.

By pressing any menu key, you can switch over to the standard display (b) or (c) *,

➔ see page 18.

► Behaviour during low voltage / overvoltage

2

1 — 12.10. 04 45km/h
123456.7km

2 — 12.10. 04 45km/h
123456.7km

3 — 12.10. †
123456.7km

Standard display (a): Fault in the supply voltage
If the supply voltage of the DTCO 1381 is too low or too high, an indication is shown in the standard display (a) as follows.

Case 1: "0†" (1) Low voltage or ...

Case 2: "04" (2) Overvoltage

The DTCO 1381 continues to save activities. The functions printing or display of data and the insertion or withdrawal of a tachograph card are not possible!

Case 3: "†" (3)

This case corresponds to a power interruption. The standard display (a) appears automatically. The DTCO 1381 cannot fulfill its role as a recording device! The driver's activities will not be recorded.

► Power interruption

1 — xx.xx.xx
2 — SWUM xx.xx
!† power-interruption xx

Display of the "Power interruption" message

As soon as the voltage is present again, the version of the user software (1) and the version of the software upgrade module (2) will appear for approximately 5 seconds.

Then the DTCO 1381 indicates "Power interruption".



If, with correct on-board voltage, the symbol "†" is displayed permanently, please contact an authorised workshop.

When the DTCO 1381 is defective, you are obligated to note activities with handwritten entries.

➔ Refer to "Handwritten activity entries" on page 36.

"Company" mode

Functions of the company card

Company card insertion

Prepare data download

Company card withdrawal

Service Only

■ Functions of the company card



The company takes care for the correct use of the company card(s). Please observe the legal stipulations applicable in your country!

3

The company card identifies the company and registers it into the DTCO 1381, the first time that the card is inserted. Thus, the access rights to the data assigned to the company will be ensured.

The inserted company card authorises you:

- To lock-in and lock-out the company when using this DTCO 1381, for example on sale of the vehicle, expiry of the vehicle lease etc.
- If necessary (one time), the entry of the member state and the vehicle registration number of the vehicle.
- To access data from the data memory and, especially data that has been assigned specifically to this company.

- Access to data from an inserted driver card.
- To display, print out or download data via the download interface.



The company card is designed for the data management of the company only and must not be used for driving! If the company card is used for driving, a message will be displayed.

Downloading of data at regular intervals is compulsory in most member states. In the following situations download of data from the data memory is also recommended:

- Sale of the vehicle,
- Immobilisation of the vehicle,
- Replacement of a defective DTCO 1381.

► Menu functions in the "company" mode

In principle, follow the same procedure when navigating in the menu functions.

➔ Refer to "Calling up menu functions" on page 48.

If, however, the company card is in card slot 2, all main menus assigned to card slot 2 will remain blocked.

➔ Refer to "Menu access blocked!" on page 56.

In this case, you can only display, print out or download data from a driver card inserted in card slot 1.

➔ Refer to "Overview of the menu structure" on page 54.

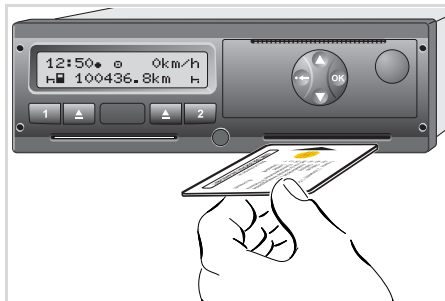

■ Company card insertion



Insert company card

1. Turn on the vehicle's ignition.
(Required only for ADR variant *.)
2. Insert your company card (with the chip facing upward and the arrow pointing forward) into any card slot.

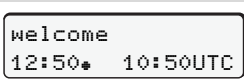
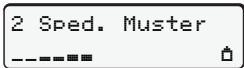
 The company card determines the language of the display. As an alternative, you can individually set a preferred language.
 ➔ Refer to "Setting the language" on page 49.

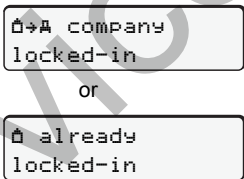
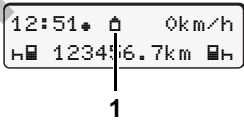
Step / menu display	Explanation / meaning
3. 	Greeting text: The set local time "12:50" and the UTC time "10:50UTC" will appear for approximately 3 seconds (time offset = 2 hours).
4. 	The name of the company appears. A progress bar indicates that the company card is being read. If required, the DTCO 1381 may order you to enter the vehicle registration number. <ul style="list-style-type: none"> • Select "Yes" and confirm with the button , ➔ see page 24.
5. 	If the company card is inserted the first time, the company will automatically be locked-in the DTCO 1381. The company lock function is activated. Thus, the protection of company-specific data is ensured!
6. 	After reading is complete, the standard display will appear. The DTCO 1381 is in the "Company" mode, symbol "🔒" (1).

► Enter vehicle registration number

Step / menu display	Explanation / meaning
<p>1. </p>	<p>If the next query appears,</p> <ul style="list-style-type: none"> • select "Yes" and confirm.
<p>2. </p>	<ul style="list-style-type: none"> • Select and acknowledge the country. <p>First character field to be entered is shown by a flashing cursor "_".</p> <ul style="list-style-type: none"> • Select and confirm desired character. • Repeat process, maximum 13 positions.
<p>3. </p>	<ul style="list-style-type: none"> • In the event that fewer characters are required, press and hold the key OK, until the last character field is flashing. • Confirm entry once again with the key OK.
<p>4. A technical data printout takes place automatically.</p>	
<p>5. </p>	<ul style="list-style-type: none"> • Please verify your entry! • Select "Yes" and confirm. <p>If the registration number is wrong, select "No" and confirm. Step 1 appears, repeat the entry.</p>

Entry:

Use the buttons **▲** or **▼** to select the desired function and confirm your selection with the **OK** button.

Correct the entry:

Gradually navigate back to the previous position with the key **◀** and repeat the entry(ies).

Printout: Technical data

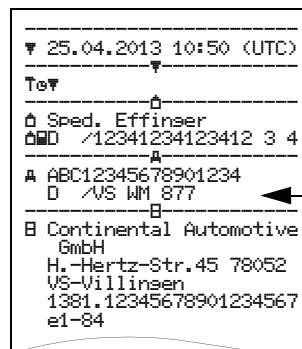

Note: The entry of the vehicle registration number is a one-time entry. Any changes can only be made by an authorised workshop.

■ Prepare data download



Danger of explosion

Please observe the instructions for transport and handling of hazardous materials in explosion-risk environments.

When loading and unloading hazardous materials ...

- the covering cap (1) must be closed
- and no data may be downloaded.

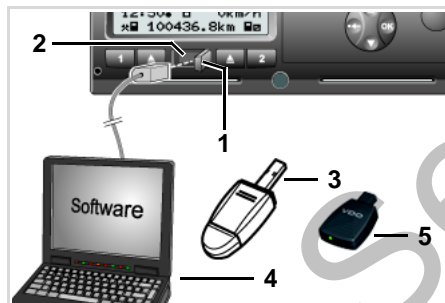

Connection to download interface

1. Open the covering cap (1) to the right.
2. Connect the Laptop (4) with the download interface (2).
3. Start the reading software.
4. Or insert the Download Key (3) into the download interface.



Communication between the DTCO 1381 and a Smartphone using a Bluetooth connection is possible with a SmartLink (5).

5. After downloading the data, make sure you always close the covering cap (1).

Data identification

Before the data is downloaded, the DTCO 1381 will attach a digital signature (identification) to the copied data. With this signature, the data can be assigned to the DTCO 1381 and permit checking of the data's completeness and authenticity.

Remote download *

With a fleet management system, data can also be downloaded remotely following authentication of a company card.



For detailed information about the reading software, please refer to the appropriate documentation.

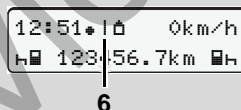

Standard display (a): Identification Data transmission running

The symbol (6) appears during the data transmission.



Do not under any circumstances interrupt the connection to the download interface. Leave the ignition on with an ADR variant *.

■ Company card withdrawal





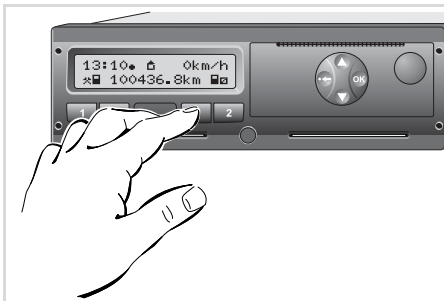

 You can only withdraw the company card from the card slot when the vehicle is not moving!

3

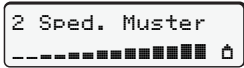
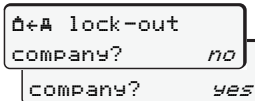
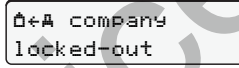

Request company card

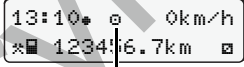
1. Turn on the vehicle's ignition.
(Required only for ADR variant *.)
2. Press the appropriate ejection button  of the card slot in which the company card is located.

Step / menu display	Explanation / meaning
<p>3. </p>	<p>The name of the company appears. A progress bar shows that the DTCO 1381 is transferring data to the company card.</p>
<p>4.  </p>	<p>No company Lock-out</p> <ul style="list-style-type: none"> • Use the buttons  /  to select "No" and acknowledge with the button . <p>Company Lock-out</p> <ul style="list-style-type: none"> • Select "Yes" and acknowledge with the button . <p>The company lock function is deactivated. The saved data of your company remains, but are locked out for any other company!</p>
<p>5.  1</p>	<p>The company card is released; the standard display appears.</p> <p>As applicable, a notice may appear that the periodical inspection is pending or the validity of the company card is expiring,  see page 76.</p> <p>The DTCO 1381 is in the "Operational" mode again, symbol "e" (1).</p>

 **Please note:** The ejection from card slot 2 is blocked if the printer drawer is open! This will be indicated by an operational note.

Operational mode

Inserting driver card(s)

Setting activities

Downloading driver card data

Withdrawing driver card(s)

Driver / vehicle change during operation

Service Only

■ Inserting driver card(s)

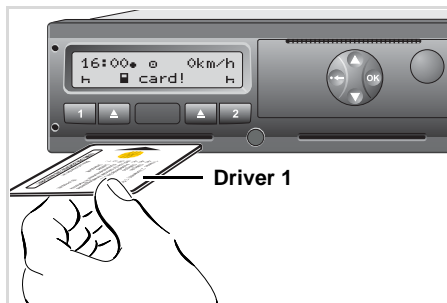

Operational note after ignition on: Driver card in slot 1 missing.

! In accordance with responsible driving behavior as described in the EU regulations and in the general interest of traffic safety, please do not attempt to insert the driver card(s) while the vehicle is in motion!

It is possible to insert the driver card while the vehicle is moving, but this will be shown and saved as an event!
 ➔ Refer to "Overview of the events" on page 68.

1. Turn on the vehicle's ignition.
(Required only for ADR variant *.)
2. **Driver 1**, who will drive the vehicle, inserts his driver card (with the chip facing upward and the arrow pointing forward) into card slot 1.
3. The subsequent procedure is menu-guided, ➔ see page 29.
4. As soon as the driver card of driver 1 has been read in, **driver 2** inserts his driver card into card slot 2.

Remark

Menu guidance is carried out in the language stored on the driver card. As an alternative, you can individually set a preferred language.

From Release 2.1: Menu functions for the display and printout of driver data are only available when a corresponding driver card is inserted. Thus the menu item "Printout driver 2", for example, is only displayed if a driver card is inserted in card slot 2.

➔ Refer to "Setting the language" on page 49.

▶ Manual entries

! According to the EU regulations, activities, which cannot be registered on the driver card, are to be added by means of manual entry. (For details on activities, ➔ see page 35.)

Withdrawal (15.04.2013)	Insertion (18.04.2013)
16:31 Local time	07:35 Local time

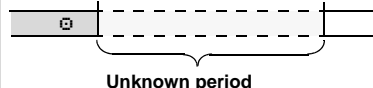

Example of unknown period

The following entry scenarios are possible after each time the driver card is inserted:

- Add activity rest period "H"; example 1, ➔ see page 32.
- Continue work shift; example 2, ➔ see page 33.
- Continue, end a work shift and/or prefix activities to a work shift; example 3, ➔ see page 34.



Fundamental course of action

- Select the desired function, activity or numeric value with the keys ▲ / ▼ in the entry field.
- Confirm your selection with the button .

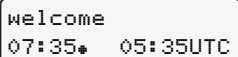
1. 

Greeting text: The set local time "07:35*" and the UTC time "05:35UTC" appear for approx. 3 seconds (time offset = 2 hours).

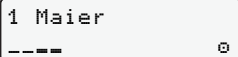
2. 

The driver's last name appears. A progress bar indicates that the driver card is being read.

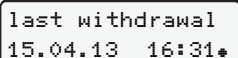
3. 

The date and time of the most recent card withdrawal will be displayed in local time (symbol "*") for approx. four seconds.

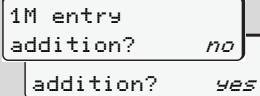
4. 

- If you do not want to add **any activities**, select "No"; for more options see step 9.
- By selecting "Yes", you request DTCO 1381 to make manual inputs.

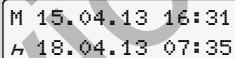
5. 

"M" = Manual entry;

"H" = Entry field of the activity is flashing

The period between removal (1st line) and current insertion (2nd line) in local time appears.

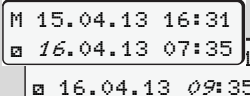
6. 

2nd line = entry block

You can successively enter the logically possible variables (flashing entry fields) in the following order:

"Activity – Day – Month – Year – Hour – Minute".

The process ends when the time of the insertion operation is reached.

The following request appears before the manual entries have been accepted (for release 2.0 subsequently to it).

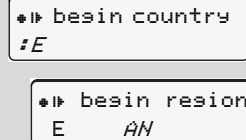
7. 

- Select and acknowledge the country.
- If required, select and acknowledge the region.
- You can abort the entry of a country with the button .

8. 1M confirm entry? *yes*
 entry? *no*

- Confirm entry with "Yes".
- Select "No".
 ➔ Refer to "Correction possibilities" on page 30.

9. 07:36* 0 km/h
 H 123456.7km H

The standard display (a) appears. Symbols of the card symbol which are displayed before have the following meaning:

- " _ " The driver card is in the card slot.
- " H " You can start the journey, relevant data are read in.

- ☞ While the driver card is being read, some functions are not possible.
- Calling up menu functions
 - Requesting a tachograph card

If a menu button or the ejection button is pressed, a message will be displayed.

please wait!
 or
 H ejection not possible xx

You can only successively correct the possible variables.

- ☞ When pressing and holding key **OK**, you will jump to the next entry field or to the next complete entry block, respectively.

► **Correction possibilities**

You can select and correct the possible variables with the key **←** (backspace) directly in the entry block.

In the event that you do not accept the entries at query "1M confirm entry?", first step 4 appears and subsequently the first entry block (step 5) requires to be completed.

4. 1M confirm entry? *yes*
 5. M 15.04.13 16:31
 H 16.04.13 07:35

► Country entry during manual entry

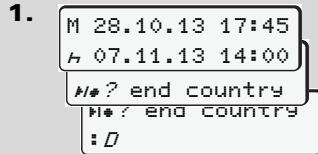

- Select and acknowledge the symbol "#/? end country" in the first entry field "H". (Only possible when the time of the first manual entry does not match the time of the country entered during the last card removal.)

- Select and acknowledge the country.

Or:

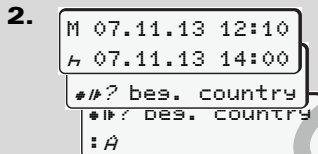

- Select and acknowledge the symbol "#/? bes. country".
- Select and acknowledge the country.

Selecting the countries

The most recently entered country appears first. By pressing the buttons ▲ / ▼, the four most recently entered countries will appear. Symbol: Colon in front of the country symbol " : B".

Further selection is made in alphabetic order starting with letter "A":

- using key ▲ A, Z, Y, X, W, ..., etc.;
 - using key ▼ A, B, C, D, E, ..., etc.
- ➔ Refer to "Country symbols" on page 89.

☞ Pressing and holding down the keys ▲ / ▼ will accelerate the selection (auto-repeat function).

► Aborting the entry procedure

If no entry is made during the entry procedure, the following display will appear after 30 seconds.

⏏ please
 enter

If the button **OK** is pressed within an additional 30 seconds, then the entry can be continued.

After this time or when driving commences, the driver card will be read to completion and the standard display **(a)** will appear. The DTCO 1381 saves any entries that have already been acknowledged with the button **OK**.

Aborting the manual entry procedure by requesting the driver card.

➔ Details refer to "Card withdrawal during manual entry" on page 38.

► Add "Rest period" activity

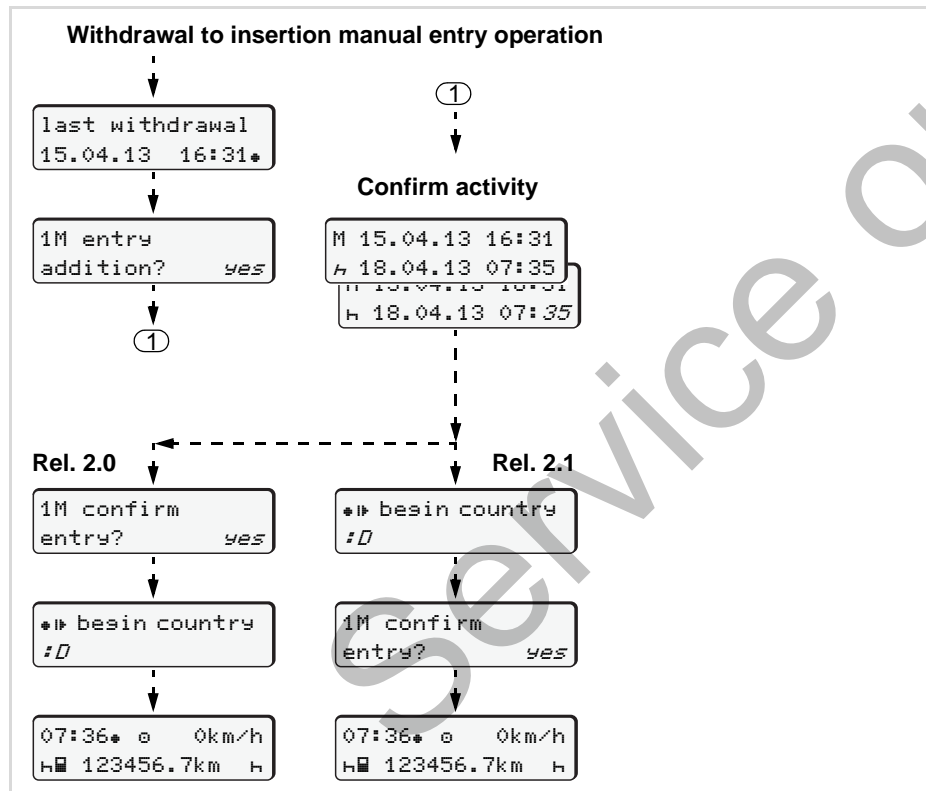

Example 1:

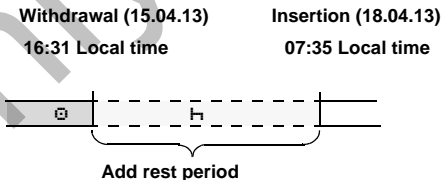

Please note: Entry takes place in local time.

1. Press and hold key **OK**.
2. Automatically jumps to the last entry field (minutes flash).
3. Confirm entry with key **OK**.
4. Follow the menu guidance.

► Continuing the work shift

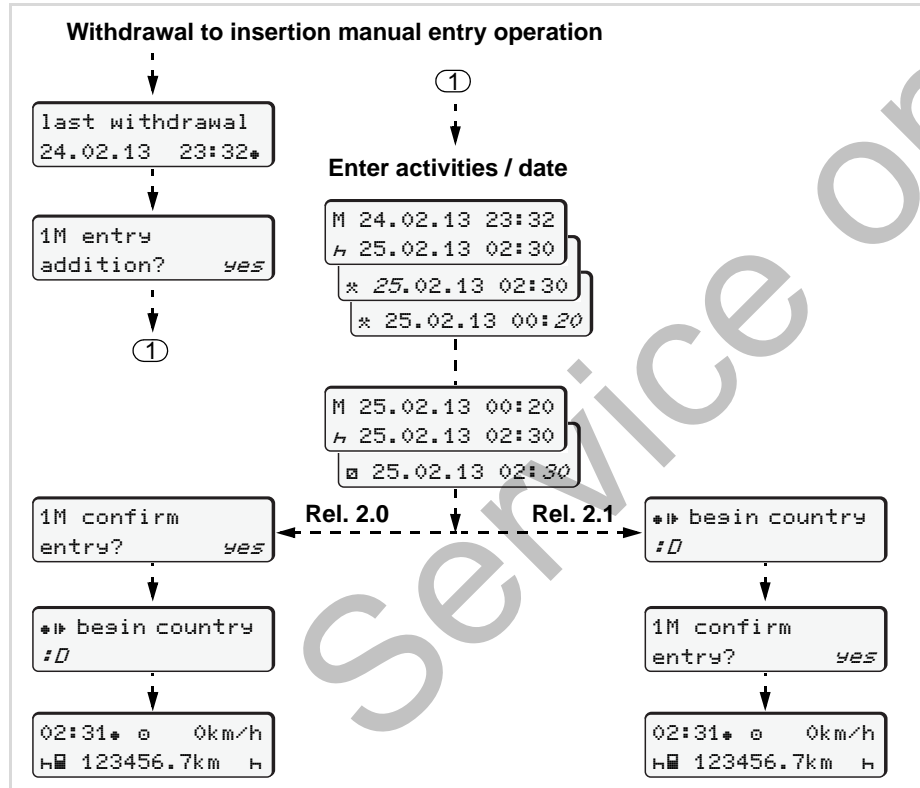
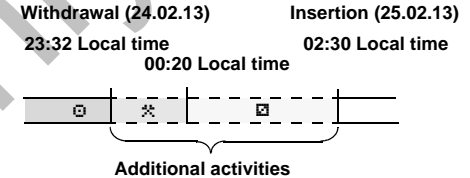
**Example 2:**

Please note: Entry takes place in local time.

1. Set and confirm first activity "∗".
2. Set and confirm the day, set and confirm hours, set and confirm minutes.
3. Set and confirm second activity "▣".
4. Press and hold key **OK**, until the minutes flash.
5. Confirm entry with key **OK**.
6. Follow the menu guidance.

■ Setting activities

- ⊖ = Driving time (automatic when driving)
- * = Other work time
- ☒ = Availability (waiting time, co-driver time, driver 2 sleeper-cab time during a journey)
- ⌂ = Break times and rest periods

▶ Manual setting

- 👉 The activities may be set only if the vehicle is stationary!

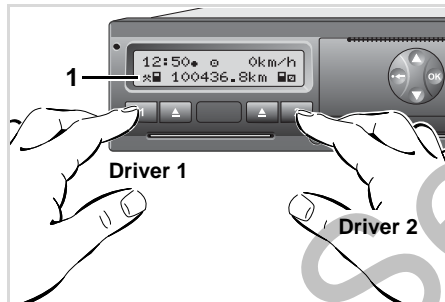

Setting activity

1. **Driver 1** presses the button **1**,
The standard display **(a)** appears.

2. Continue pressing the button until the desired activity (⌂ ☒ *) appears in the display **(1)**. After approx. 5 seconds, the previous display appears.

3. **Driver 2** presses the button **2**.

▶ Automatic setting

The DTCO 1381 switches automatically to the following activities:

for ...	Driver 1	Driver 2
Driving	⊖	☒
Vehicle stop	*	☒

- ⚠ At the end of a shift or at the start of a break, **always** set the activity to "⌂". This will ensure that the VDO Counter * provides an accurate calculation.

▶ Automatic setting after ignition on/off *

After ignition on/off, the DTCO 1381 can be configured to switch to a defined activity; for example "⌂".

The activity **(1)** and/or **(2)** which changes automatically on the basis of ignition on or off, appears in the standard display **(a)** and flashes for approx. 5 seconds. Then, the previous display will appear again.

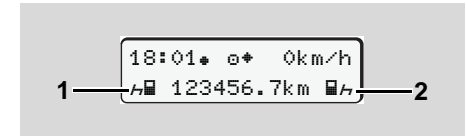

Flashing of the activity(ies) in the standard display (a)

- 👉 As necessary, change the set activity according to your current task.

Note

Which activity is triggered automatically by the DTCO 1381 on switching the ignition on / off can be programmed according to the customer's wishes by an authorised workshop; ➔ see page 112.

▶ Handwritten activity entries

According to the directive, you (as driver) are obligated to note activities with handwritten entries in the following cases:





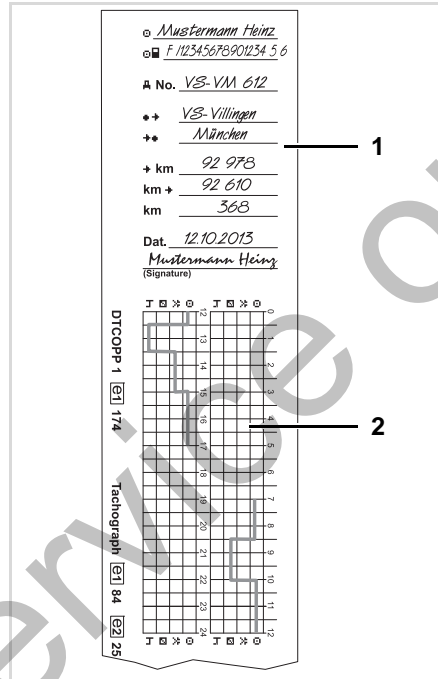





- When the DTCO 1381 is defective.
- If the driver card is lost, stolen, damaged, or if the driver card malfunctions, a daily printout from the DTCO 1381 must be generated at the beginning and end of the journey. If necessary, you must insert the availability and other working times by handwritten entries.

The rear side of the paper roll can be used to make handwritten entries **(2)** of your activities and to complete the printout by personal information **(1)**.



Handwritten activity entries

Personal information

-  First and last name
-  Number of the driver card or the driving licence
-  No. Vehicle registration number
-  Location at the beginning of the shift
-  Location at the end of the shift
-  +km Odometer reading at the end of the shift
-  km+ Odometer reading at the beginning of the shift
-  km Kilometres travelled
-  Dat. Date
-  Sig. Personal signature



Please observe the legal stipulations applicable in your country!

■ Downloading driver card data



Danger of explosion

Please observe the instructions for transport and handling of hazardous materials in explosion-risk environments.

When loading and unloading hazardous materials ...

- the covering cap (1) must be closed
- and no data may be downloaded.

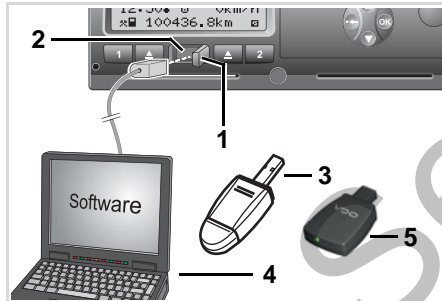

Connection to download interface



Please make sure that only one driver card is inserted! Otherwise there will be no transfer of data.

1. Open the covering cap (1) to the right.
2. Connect the Laptop (4) with the download interface (2).
3. Start the reading software.
4. Or insert the Download Key (3) into the download interface.



Communication between the DTCO 1381 and a Smartphone using a Bluetooth connection is possible with a SmartLink (5).

The symbol (6) appears during the data transmission.



Do not under any circumstances interrupt the connection to the download interface. Leave the ignition on with an ADR variant *.

5. After downloading the data, make sure you always close the covering cap (1).

Data identification

The copied data are provided with a digital signature (identifier). With this signature, the data can be assigned to the driver card and permit checking of the data's completeness and authenticity.



For detailed information about the reading software, please refer to the appropriate documentation.

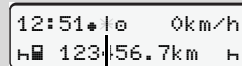

6

Standard display (a): Identification Data transmission running

■ **Withdrawing driver card(s)**

 In principle, the driver card can remain in the card slot at the end of the work shift – please enter the activity "H".
However, when the driver or vehicle is changed, the driver card should generally be withdrawn from the card slot.
➔ Refer to "Driver / vehicle change during operation" on page 40.

 You can withdraw the driver card from the card slot only when the vehicle is not moving!

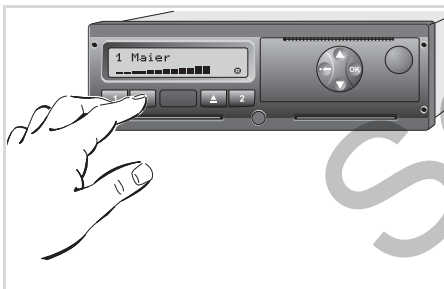

Driver card request

1. Turn on the vehicle's ignition. (Required only for ADR variant *.)
2. Enter the corresponding activity; for example, at the end of the work shift to "H".
3. Press the ejection button  for card slot 1 or card slot 2. The subsequent procedure is menu-guided, ➔ see page 39.

 The ejection from card slot 2 is blocked if the printer drawer is open! This will be indicated by the following operational note.

 drawer open
XX

As soon as you close the printer drawer, the ejection will be started.

Card withdrawal during manual entry

1. Press the corresponding ejection button .
2. Select and acknowledge the following queries with "No".



1M confirm
entry? no



1M entry
addition? no

3. Continue, ➔ see page 39.

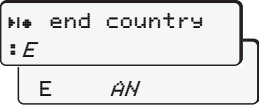
The manual entry is aborted, the DTCO 1381 saves the activity "?" for the unknown period.

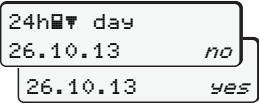
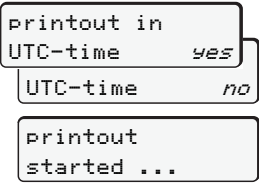
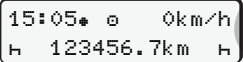
► Menu guidance after withdrawing driver card

Step / menu display	Explanation / meaning
1. 	The driver's last name appears. A progress bar shows that the DTCO 1381 is transferring data to the driver card.
2. 	<ul style="list-style-type: none"> • Select and acknowledge the country. • If required, select and acknowledge the region. • Use button  to abort the entry of a country if you, for example, want to continue your work shift.
3. 	<ul style="list-style-type: none"> • Select "Yes" and acknowledge if you need a printout, otherwise acknowledge "No".
4. 	<ul style="list-style-type: none"> • Acknowledge "Yes" if you want the printout in UTC-time (required by law). • If you select "No" and acknowledge, you will receive a printout in "Local time". <p>When the function is selected, the continuation of the action will appear in the display.</p>
5. 	The driver card is released; the standard display (a) appears.

Use the buttons  or  to select the country and confirm your selection with the  button.

4

A message may appear in advance that the validity of the driver card is due to expire, a periodic inspection is due, or the next download of the driver card is required (from Release 2.1).

➔ see page 76.

■ Driver / vehicle change during operation

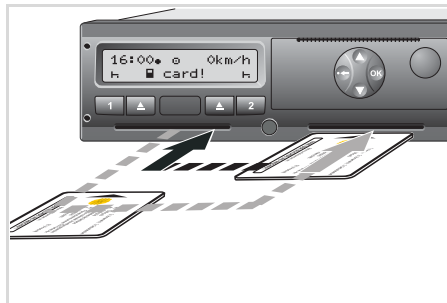

Exchanging driver card(s)

Case 1: The crew exchanges positions, driver 2 becomes driver 1

1. Withdraw the driver cards from their respective card slots and exchange them by inserting them into the other card slots.

Driver 2 (**now driver 1**) first inserts his driver card into card slot 1 and driver 1 (**now driver 2**) inserts his driver card into card slot 2.

2. Set the desired activity.

Case 2: Driver 1 and/or driver 2 leave the vehicle

1. The driver who is leaving the vehicle requests his driver card, generates a daily printout, if necessary, and takes the driver card out of the DTCO 1381.
2. The new vehicle crew insert their new driver cards, depending on function (driver 1 or driver 2), into the card slots.

Case 3 – Mixed operation: Vehicle usage with different tachograph types

- For example, analogue tachographs or ...
- Digital tachographs with driver card according to EC Regulation (EEC) no. 3821/85 annex I B, e.g. DTCO 1381.

During an inspection, the driver must be able to present the following items for the current day and for the previous 28 calendar days:

- the driver card (1),

- the relevant daily printouts from the digital tachograph (2), e.g., if the driver card is damaged or fails to operate properly,
- the charts covered with data (3)
- and, if necessary, handwritten information concerning the activities.

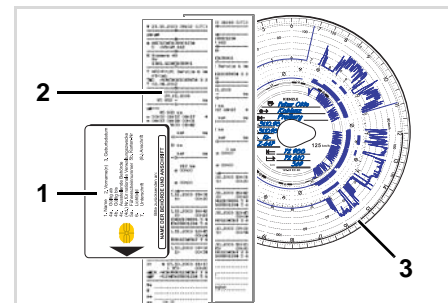

Please observe the legal stipulations applicable in your country!

► Documents to be kept while driving

Convalescence / Recreation holiday:

Pursuant to directive 2006/22/EC of the European Commission, the driver must have an attestation relating to the following circumstances over the previous 28 days:

- Period during which the driver was on sick leave.
- Period during which the driver was on holiday.
- Period for a journey which took place outside of the scope of application of Council Regulation (EC) No. 561/2006 or the AETR.



You will find a printable version of the form on the Internet at:
ec.europa.eu

ATTESTATION OF ACTIVITIES (1) (REGULATION (EC) No 561/2006 OR THE AETR (2))	
<i>To be filled in by typing and signed before a journey. To be kept with the original control device records wherever they are required.</i>	
False attestations constitute an infringement	
Part to be filled in by the undertaking	
1. Name of the undertaking:	
2. Street address, postal code, city, country:	
3. Telephone number (including international prefix):	
4. Fax number (including international prefix):	
5. E-mail address:	
I, the undersigned:	
6. Name and first name:	
7. Position in the undertaking:	
declare that the driver:	
8. Name and first name:	
9. Date of birth (day/month/year):	
10. Driving licence or identity card or passport number:	
11. who has started to work at the undertaking on (day/month/year):	
for the period:	
12. from (hour/day/month/year):	
13. to (hour/day/month/year):	
14. <input type="checkbox"/> was on sick leave (*)	
15. <input type="checkbox"/> was on annual leave (*)	
16. <input type="checkbox"/> was on leave or rest (*)	
17. <input type="checkbox"/> drove a vehicle exempted from the scope of Regulation (EC) No 561/2006 or the A	
18. <input type="checkbox"/> performed other work than driving (*)	
19. <input type="checkbox"/> was available (*)	
20. Place:	Date:
Signature	
1. I, the driver, confirm that I have not been driving a vehicle falling under the scope of Reg the AETR during the period mentioned above.	
2. Place:	Date:
Signature of the driver	

Extract: Form sheet Activities

<http://eur-lex.europa.eu/LexUriServ/LexUriServ.do?uri=OJ:L:2009:330:0080:0081:EN:PDF>

Abnormal cases:

Provided that road safety is not thereby jeopardised and to enable the vehicle to reach a suitable stopping place, the driver may depart from Drivers Hours rules to the extent necessary to ensure the safety of persons, of the vehicle or its load. The driver should indicate the reason for such departure at the latest on arrival at a suitable stopping place:

- manually on a chart
- printout from the DTCO 1381
- or in the duty roster.

Service only

Printer Handling

Insert paper roll

Printout of data

Service only

■ Insert paper roll

-  **Please note!**
Use (order) only paper rolls (original VDO printer paper) on which is visible the following markings:
- Tachograph type (DTCO 1381) with approval mark "E184"
 - and approval marks "E174" or "E189".



Danger of injury
Depending on the volume of information printed, the thermal printing head may be very hot. You can burn your fingers!

Exercise caution when inserting the roll of paper or wait until the printing head has cooled.



Make sure that the paper roll does not become jammed in the printer drawer and the start of the paper (1) extends beyond the edge of the printer drawer!

3. Close printer drawer.
The printer will automatically start feeding the paper forward.

5



Press the unlock button

1. Press the unlock button. The printer drawer opens.

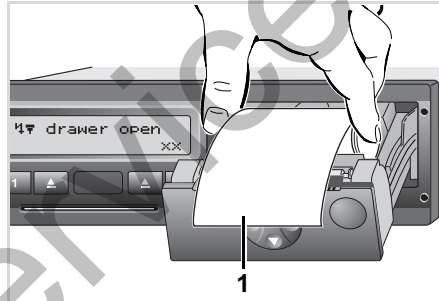

Insert paper roll

2. Insert new roll of paper as shown in the image above.



Danger of injury
Make sure that the printer drawer is always closed. You and other persons might be injured by an open printer drawer.

4. The printer is ready for operation. You can start a printout or the interrupted printout (at the end of the paper roll) will be continued automatically.

■ Printout of data

▶ Start printout

-  Printing is only possible when ...
- the vehicle is stationary and the ignition is switched on (required only for ADR variant *),
 - the printer drawer is closed and a roll of paper is inserted,
 - no other faults prevent printing.



1. Either the menu guidance will command you to make a daily printout after "Withdraw driver card" (1), or you request the corresponding printout through the menu (2).
 ➔ Refer to "Calling up menu functions" on page 48.

2. Acknowledge the menu display with the **OK** button.
3. Select and acknowledge the printout type (UTC or local time).
4. The printout will start. Wait until the printout is complete.

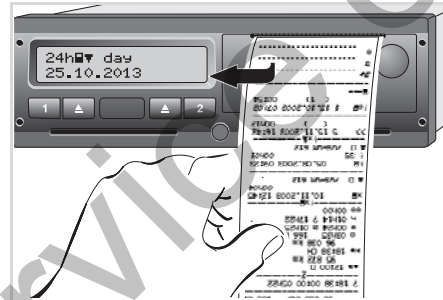

Tear off the printout from the paper roll

5. Pull the printout up and down over the cutting edge and then tear the printout from the roll of paper.
6. The printout should be kept clean and protected from dirt, strong light, and sunlight.

▶ Cancel printout

1. While the printout is running, press the button **OK** and the following question will appear.

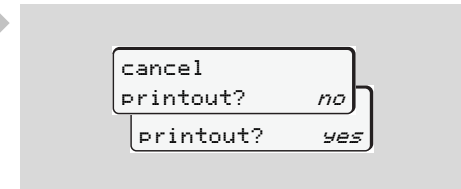

2. Use the buttons **▲** / **▼** to select the desired functions and confirm your choice with the button **OK**. The printout will be either continued or cancelled.

► Things to note when printing

- If the shift started before 00:00 UTC time, after "Withdrawing the driver card" the DTCO 1381 will automatically print the daily values of the previous day and the current day.
- You will see a coloured mark **(1)** on the rear side of the printout shortly before the paper roll is empty.
- When the paper roll is empty, you will see the following message.

```

  4 0 no paper
  xx
  
```

- If a new roll of paper is inserted within one hour, the DTCO 1381 automatically continues the printout.
- A notice is given in the first two lines of the subsequent printout **(3)**.

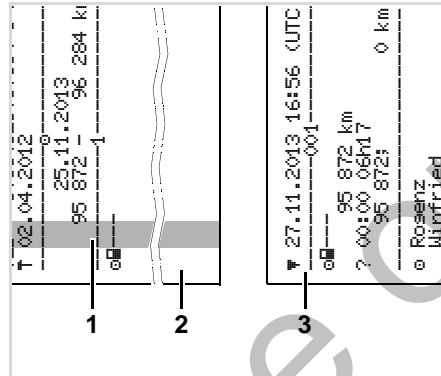

Continuing the printout at the end of the paper roll.

- (1)** Coloured mark (on the rear side)
- (2)** End of the interrupted printout
- (3)** Continuation of the interrupted printout
Line 1: Start time of printout
Line 2: The following printout counter

 Individual lines of the first printout may be repeated on the second printout!

► Clear paper jam

If a printout is not torn off properly, the paper may become jammed and then prevent the next printout from coming through the paper slot.

1. Open printer drawer.
 - Refer to "Insert paper roll" on page 44.
2. Tear off any crumpled paper from the roll and remove any remaining bits of paper from the printer drawer.
3. Insert paper roll again and close printer drawer.



Please observe the given warning messages!

➤ Refer to "Insert paper roll" on page 44.

Menu functions

Calling up menu functions

VDO Counter *

Overview of the menu structure

Main menu printout driver 1 / driver 2

Main menu, vehicle printout

Main menu entry driver 1 / driver 2

Main menu entry vehicle

Main menu display driver 1 / driver 2

Main menu display vehicle

■ Calling up menu functions

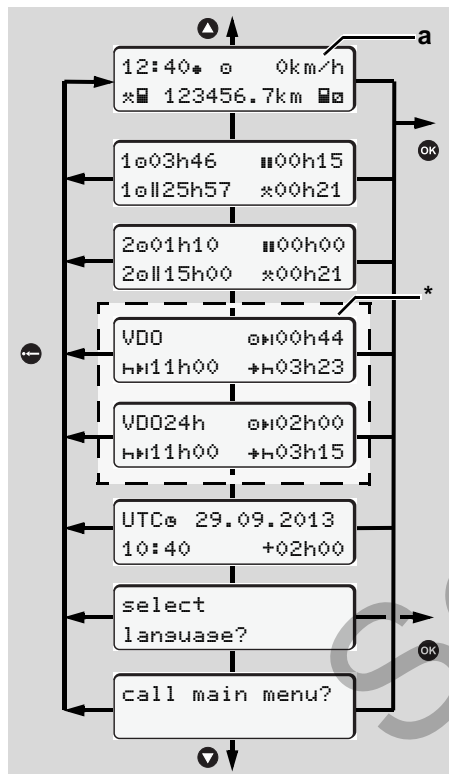

Navigating in the standard display

From Release 2.1: Menu functions for the display and printout of driver data are only available when a corresponding driver card is inserted. Thus the menu item "printout driver 2", for example, is only displayed if a driver card is inserted in card slot 2.

▶ **When the vehicle is stationary**

You can access the following information with the keys ▲ / ▼ within the first menu level.

- Detailed times of the inserted driver card(s).
- VDO Counter * information - daily and weekly driving, work, rest / break time planning and availability.
 - ➔ For more details, see "VDO Counter *" from page 50.
- The UTC time with date as well as the set offset for the local time.
- The menu to set the desired language.
 - ➔ Refer to "Setting the language" on page 49.

- Use the key ⏪ to return directly to the standard display (a).

The extensive menu functions will appear when pressing the key ⏹.

➔ Refer to "Overview of the menu structure" on page 54.

▶ **Change of activities**

1. When pressing key **1** / **2**, the standard display (a) will appear.
2. If necessary, change the currently displayed activity. After 5 seconds, the DTCO 1381 switches back to the previously set display.

▶ **Display at start of drive**

When driving commences, the most recently set standard display (a), (b) or (c) appears.

➔ Details refer to "Standard display(s)" on page 18.

► Displaying the times of the driver card

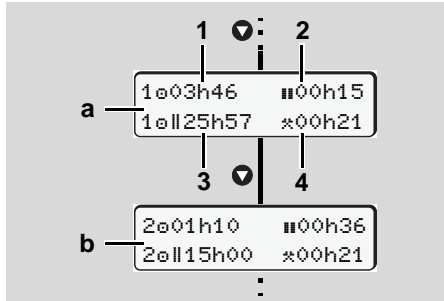

Data display of driver 1 and 2

- (a) Times of driver 1
(b) Times of driver 2

- (1) Driving time "e" of Driver 1 since a valid break time.
- (2) Valid break time "||" in cumulative break periods of at least 15 minutes followed by 30 minutes, in accordance with regulation (EU) no. 561/2006.
- (3) Sum of driving times over two weeks
- (4) Duration of the set activity

☞ If the driver card is missing, times (except for pos. 3) which are assigned to the respective card slot "1" or "2" will appear.

► Setting the language

☞ Observe the paragraph "Storing the language setting" so that the DTCO 1381 will temporarily memorise the desired language.

1. Use the buttons ▲ / ▼ to select the function "select language?" and press the button **OK**.
2. Use the buttons ▲ / ▼ to select the desired function and confirm your selection with the **OK** button.

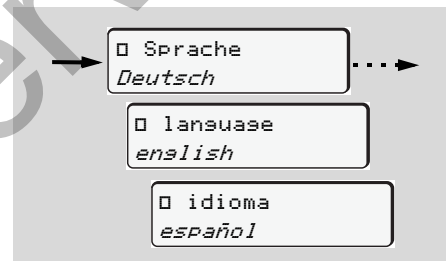

Select the desired language

3. The DTCO 1381 indicates the action for about three seconds in the selected language.

Storing the language selection

If, at the time of the language setting, only your driver card or company card is in the card slot 1, the DTCO 1381 memorises the preferred language for your card number.

When withdrawing / inserting the tachograph card again, the menu guidance as well as all displayed texts will be in the selected language.

The DTCO 1381 reserves up to five storage areas. If all storage areas are full, the oldest saved value will be overwritten.

■ VDO Counter *



Please note!

Because of differing interpretations that may be made by the enforcement authorities with regard to the Reg. (EU) 561/2006 and the AETR Regulations and because of other system constraints the VDO Counter does not discharge the user from his obligation to register his driving, rest, availability and other working times and to evaluate them by himself to allow him compliance with the regulations in force. The VDO Counter does not claim to display the legal regulations in a generally valid and error free manner.



The following conditions are obligatory in order to analyse the data and display useful Drivers Hours information:

- Complete shift time activities, including manual entries to the driver card.
- Correct activity settings during the shift - no operational error. For example, unintentional setting of the work time

activity "*" instead of a daily rest period "H"!

- Entry of ferry/train special condition and the current activity.

▶ Layout of the VDO Counter display

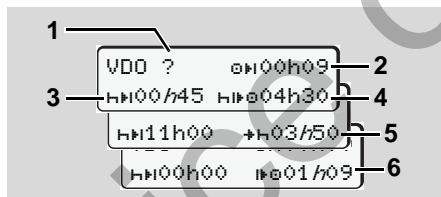

VDO Counter: Layout of the display



The flashing "h" means that this part of the display is currently active.

(1) "?" = User information

Periods with unknown activity "?" or insufficient data are recorded on the driver card (e.g. use of a new driver card). The VDO Counter evaluates unknown activities, as the activity "H".
Release 2.1: If a relevant time overlap is determined in the driver activities,

then this will be shown in the display by the "!00" symbol instead of the "?" symbol.

(2) Remaining driving time "0H"

When driving, the display indicates remaining driving time available.
 (0H00h00 = Driving time completed)

(3) Remaining break time "HH"

Duration of the next required break time / rest period. While the activity "H" is set, the remaining break time will be counted down.
 (HH00h00 = break finished)

(4) Next available driving time "HH:00" (Rel. 2.0: "H0H")

Duration of the available driving time after after completion of a required break / rest period.

(5) Latest start of the daily rest period "+H"

For example, with the activity "*" being set, the remaining time until the start of your next required daily rest period is displayed.



(6) Beginning of the next driving**time "t" (Rel. 2.0: "t")**

You may begin the next driving period only after the end of this time.

► Displays during trip

Please observe the country-specific regulations related to working time!

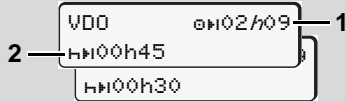
Example 1:

Activity "a"; "h" = active display

(1) Remaining driving time.

(2) At the end of the driving time **(1)**, at the latest the duration of break (full or continuation of the cumulative break time) shown must be taken.

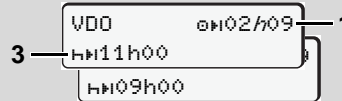
Example 2:

Activity "a"; "h" = active display

(3) At the end of the driving time **(1)** at the latest, the legally stipulated rest period displayed must be taken. The rest period may be taken in two parts, the first at least 3 hours long and the second at least 9 hours long.

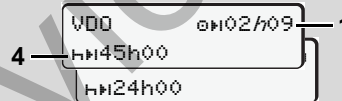
Example 3:

Activity "a"; "h" = active display

(4) At the end of the driving time **(1)** at the latest, a regular weekly rest period must be taken or, if allowed, a reduced weekly rest period.

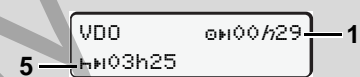
Example 4:

Activity "a"; "h" = active display

(5) The VDO counter takes into consideration a ferry/train specific condition. Prerequisite: correct entry of this specific condition, see page 61. At the end of the driving time **(1)** at the latest, the daily rest period should continue.

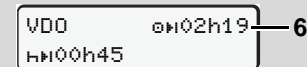
Example 5: OUT of scope

Activity "a"; Out of scope set

(6) The display of the remaining driving time is not active ("h" does not flash), there is no counting down. The VDO Counter evaluates activity "a" as activity "x".

► Display for activity "Break time"

Example 1: Break time

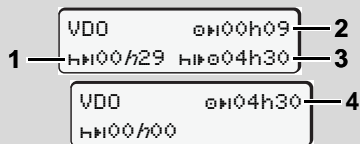

Activity "H"; "h" = active display

- (1) Remaining break time.
- (2) Remaining driving time if the break time (1) is disregarded.
- (3) Duration of the next available driving time after the end of the displayed break time (1).
- (4) Available driving time after a valid break time.

Example 2: Break time

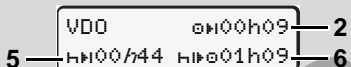

Activity "H"; "h" = active display

- (5) Remaining break time.
- (6) Duration of the available daily driving time after after completion of a required break time (5).

Example 3: Daily rest period

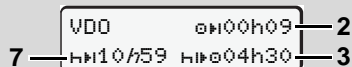

Activity "H"; "h" = active display

- (7) Remaining daily rest period.
If applicable, divided into 3 + 9 hours.

Example 4:



Activity "H"; "h" = active display

- (8) Valid break / rest time has been completed.
- (9) Start of next driving time.
Situation: The max. weekly or two weekly driving time has been completed. The daily / weekly rest period has been completed but the new daily driving time can only be started after the displayed time. (Due to no remaining time left in the current fixed week.)

► Display for activity "Working time"



Please observe the country-specific regulations related to working time!

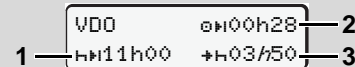



Activity "x"; "h" = active display

- (1) Duration of the next daily rest period.
- (2) Remaining current driving time .
- (3) Remaining time till next daily rest period.

At the latest before the displayed time reaches zero, a daily rest period must begin.

Note:

The VDO Counter evaluates availability activity "x" as break time "H" during an interruption of the driving time period (but not as daily rest).

You can access further information with the keys.  / .

► Display daily values

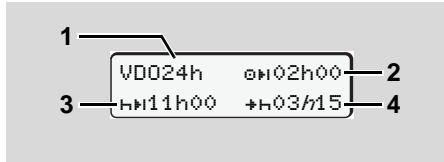

Activity "%/□"; "h" = active display

- (1) Symbol for the display of the daily values.
- (2) Remaining daily driving time.
- (3) Duration of the next daily rest period.
- (4) At the latest before the displayed time reaches zero, a daily rest period must begin.

► Display weekly values

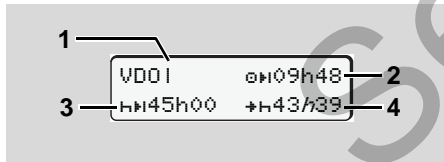

Activity "%/□"; "h" = active display

- (1) Symbol for the display of the weekly values since the last weekly rest period.
- (2) Remaining weekly driving time.
- (3) Duration of the weekly rest period.
By the end of six consecutive 24-hour periods from the end of the last weekly rest period there must be a new weekly rest period.
- (4) At the latest before the displayed time reaches zero, the weekly rest period must begin.

► Status display

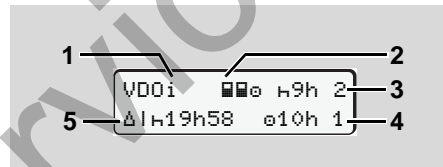

VDO Counter status display

- (1) Symbol for the status display.
- (2) Symbol for crew of two drivers (multi-manning).
Is displayed if crew operation takes place from the beginning of the work shift. The VDO Counter considers the

- respective valid rules in its calculations. The VDO Counter takes into consideration multi manning rules.
- (3) During this week, a further two reduced daily rest periods can be taken (maximum 3 times per week).
- (4) During this week, a further extended daily driving period (up to a max. 10 hours) can be taken (maximum 2 times per week).
- (5) Reduced weekly rest compensation. Due to a reduced weekly rest period, the time shown must be compensated together with another rest period of at least 9 hours in one block.

■ Overview of the menu structure

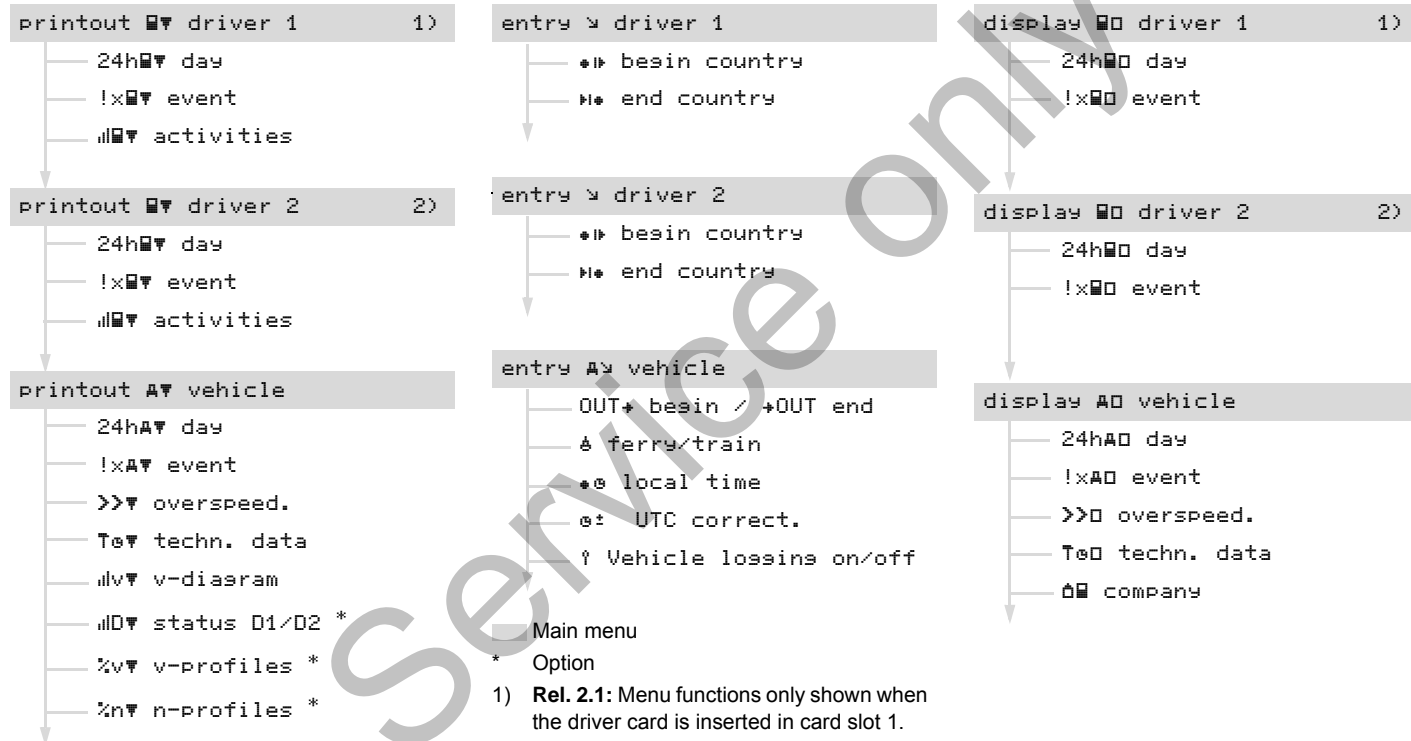

Main menu

* Option

- 1) **Rel. 2.1:** Menu functions only shown when the driver card is inserted in card slot 1.
- 2) **Rel. 2.1:** Menu functions only shown when the driver card is inserted in card slot 2.

► Navigating in the menu functions

 The menu functions may be called only if the vehicle is stationary!

Turn on the vehicle's ignition if you plan to printout or display data in the ADR variant *.

The procedure is always the same and will be described below in detail.

1. Press the button , you will be in the first main menu.

From Release 2.1: The display in the first main menu with regard to the display and print menus is based on the driver cards inserted in card slots 1 and 2.

- "printout driver 1" is displayed when a driver card is inserted in card slot 1.
- "printout driver 2" is displayed when a driver card is inserted in card slot 2 and card slot 1 is empty.
- "printout vehicle" is displayed when no driver cards are inserted.

This does not apply for the input menus.

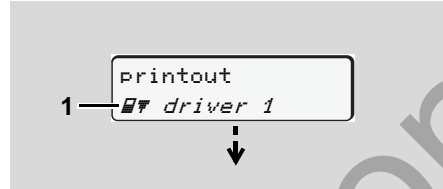

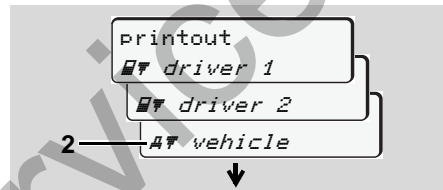

1. Main menu

The flashing action in the second line (*shown in italics*) (1) indicates that there are additional selection possibilities.



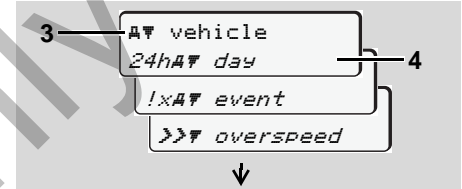

Paging in the main menu

2. Select the desired main menu with the keys  / , for example a printout of the vehicle data (2), and confirm the selection with the key .





Selecting a menu function

The selected main menu (3) will appear, the possible functions will flash in the second line (4).

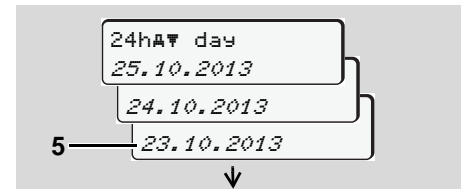
3. Select the desired function with the keys  / , for example a daily printout (4), and confirm the selection with the key .



Select desired day

4. Use the buttons  /  to select the desired day (5) and acknowledge the selection with the button .

6



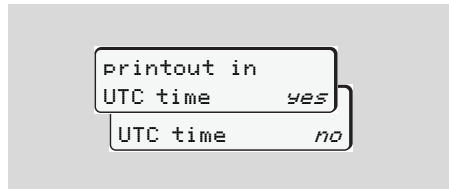

"No" = Printout in local time

5. Select the desired printing type with the keys **▲** / **▼** and confirm the selection with the key **OK**.

The DTCO 1381 reports for 3 seconds that a printout has started. If necessary, you can abort the printout.

➔ *Details refer to "Cancel printout" on page 45.*

The most recently selected menu function will then appear.

6. Select another printout with the keys **▲** / **▼**.
7. Or press the button **⊖** and return to the next-higher menu level.

▶ **Menu access blocked!**

Example 1: The driver card is missing or a company card / control card is in the card slot.

The main menu will be shown, but nothing will be flashing in the second line.

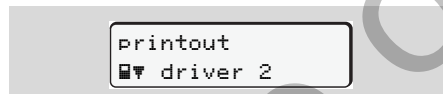

If you select this function, an operational note "no data!" will be displayed.

Example 2: Data access blocked

Access to saved data is regulated by access rights in accordance with the regulations and implemented by means of the respective tachograph cards. Lack of proper authentication is indicated as follows:

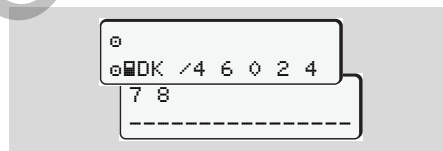

The data appears truncated. Personal data is partially or completely masked.

▶ **Leaving menu functions**

Automatically

The menu is exited automatically in the following situations:

- after a tachograph card is inserted or withdrawn
- or when driving commences.

Manually

1. Continue pressing the button **⊖**, until the following question appears.

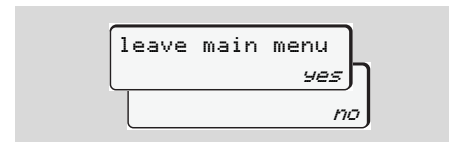

2. Use the buttons **▲** / **▼** to select "Yes" and acknowledge with the button **OK**. Or use the button **⊖** to skip the query. The standard display **(a)** appears.

■ Main menu printout driver 1 / driver 2

From this menu you can print out the data of an inserted driver card.

Select the listed functions step by step.

 Switch on the ignition in the ADR variant*.

Remark

The procedure for driver 2 is identical to that for driver 1 and will not be explained separately. You can select the desired printout type prior to every printout.

```
printout in
UTC time   yes
UTC time   no
```

"No" = Printout in local time

► Print daily value

1.

```
printout
[ ] driver 1
```
2.

```
[ ] driver 1
24h [ ] day
```
3.

```
24h [ ] day
23.10.2013
22.10.2013
```

A printout of all activities on the selected day will be made, ➔ see page 91.

► Print events

1.

```
printout
[ ] driver 1
```
2.

```
[ ] driver 1
!x [ ] event
```

A printout of all saved or still active events and faults will be made, ➔ see page 92.

► Print activities

1.

```
printout
[ ] driver 1
```
2.

```
[ ] driver 1
[ ] activities
```
3.

```
[ ] activities
23.10.2013
22.10.2013
```

From the selected day on, there is a printout of all activities of the last 7 calendar days, ➔ see page 96.

■ Main menu, vehicle printout

From this main menu you can print data from the data memory.

Select the listed functions step by step.

 Switch on the ignition in the ADR variant*.

Note

You can select the desired printout type prior to every printout.

6

```
printout in
UTC time   yes
UTC time   no
```

"No" = Printout in local time

► Print daily value from the data memory

```
1. printout
   A vehicle
```

```
2. A vehicle
   24h day
```

```
3. 24h day
   25.10.2013
   24.10.2013
```

A printout of all driver activities in chronological order, separated by driver 1/ driver 2 will be made, [see page 93](#).

► Print events from the data memory

```
1. printout
   A vehicle
```

```
2. A vehicle
   !X event
```

A printout of all saved or still active events and faults will be made, [see page 94](#).

► Print instances of over-speeding

```
1. printout
   A vehicle
```

```
2. A vehicle
   >> overspeed
```

A printout will be made of instances when the overspeed value set in the DTCO 1381 was exceeded, [see page 95](#).

► Print technical data

```
1. printout
   A vehicle
```

```
2. A vehicle
   T techn. data
```

A printout of data about vehicle identification, sensor identification, and calibration will be made, [see page 95](#). 

► **Print v-diagram**

1. `printout`
`A vehicle`
2. `A vehicle`
`ilv v-diaaram`
3. `ilv v-diaaram`
`25.10.2013`
`24.10.2013`

From the selected day on, there is a print-out of speed data, ➔ see page 96.

► **Print D1/D2 status ***

1. `printout`
`A vehicle`
2. `A vehicle`
`ilD status D1/D2`
3. `ilD status D1/D2`
`25.10.2013`
`24.10.2013`

From the selected day on, there is a print-out of status inputs of the last 7 calendar days, ➔ see page 96.

► **Print speed profiles ***

1. `printout`
`A vehicle`
2. `A vehicle`
`%v v-profiles`
3. `%v v-profiles`
`25.10.2013`
`25.10.2013`

A profile printout of the driven speeds will be made, ➔ see page 97.

► **Print rpm profiles ***

1. `printout`
`A vehicle`
2. `A vehicle`
`%n n-profiles`

3. `%n n-profiles`
`25.10.2013`
`25.10.2013`

A profile printout of the engine speed rpm will be made, ➔ see page 97.

■ Main menu entry driver 1 / driver 2

You can enter the country independently of the function of inserting or withdrawing the driver card.



According to the regulations, driver 1 and driver 2 must separately enter into the tachograph the country in which the respective driver begins or ends his shift.

Remark

- 6** The procedure for driver 2 is identical to that for driver 1 and will not be explained separately.

► Enter Begin country

Select the following functions step by step:

1. `entry`
`▼ driver 1`
2. `▼ driver 1`
`*► begin country`
3. `*► begin country`
`28.10 11:30 :D`
`28.10 11:30 :E`
4. `*► begin region`
`11:30 E AN`

If necessary, you may be automatically asked to enter the region (step 4).

► Enter End country

Select the following functions step by step:

1. `entry`
`▼ driver 1`
2. `▼ driver 1`
`*► end country`
3. `*► end country`
`29.10 11:30 :F`
`29.10 11:30 :E`
4. `*► end region`
`11:30 E AN`

If necessary, you may be automatically asked to enter the region (step 4).

■ Main menu entry vehicle

You can perform the following entries in this main menu.

▶ Enter Out beginning / end

If you use the vehicle for a journey outside of the scope of the regulations, you can set the function to "Out of Scope" and/or end it again.

Select the following functions step by step.

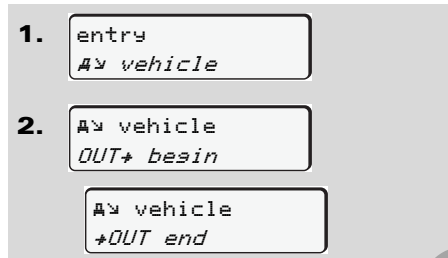

The setting "Out of Scope" ends automatically as soon as you insert a driver card into card slot 1 or withdraw a driver card from slot.

▶ Enter Beginning of ferry / train

Select the ferry / train specific condition, when you are about to drive on to the ferry / train or when you have just parked up on the ferry / train.

Select the following functions step by step.

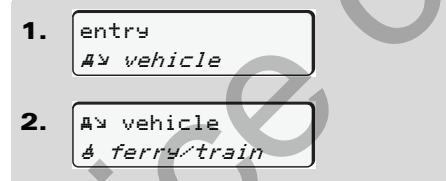

3. Then set your current activity using key **1**.

The recording of the port operation is automatically ended as soon as a one-minute driving period has been recorded by the DTCO 1381.

The "↗" symbol is no longer displayed when the vehicle is moving. The display is shown again however when the vehicle stops before one minute of driving time is recorded by the DTCO 1381.

▶ Set Local time

Read and understand the chapter "Time management" before attempting to make any changes!
 ➔ Refer to "Time management" on page 82.

Select the listed functions step by step.

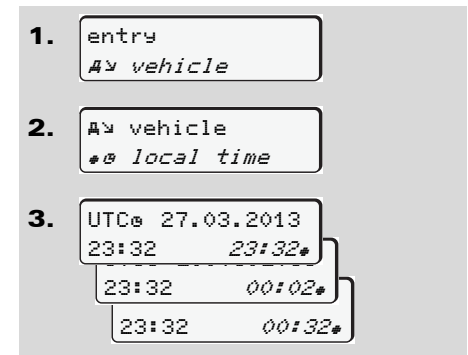

In the standard display, you may adjust the time to the local time zone as well as to the beginning or end of daylight-savings time in steps of ±30 minutes.



Please observe the legal stipulations applicable in your country!

► Make UTC correction

You can correct the UTC time up to a maximum of ± 1 minute per week. Greater deviations can only be corrected by an authorised workshop.

Select the following functions step by step:

1. `entry`
`A↘ vehicle`
2. `A↘ vehicle`
`⊗± UTC correct.`
3. `⊗± 23:32UTC`
`correction +1min`
`correction -1min`



If the deviation of the displayed UTC time is more than 20 minutes, please contact an authorised workshop!



The menu function is disabled in the following situations:

- A correction has already taken place within the last seven days.
- or
- You are trying to correct the UTC time between one minute before and one minute after midnight.

When selecting, the following note will appear for three seconds.

`⊗± UTC correct.`
`impossible!`

■ Main menu display driver 1 / driver 2

From this menu you can display the data of an inserted driver card.



 In the ADR variant *, the data can be displayed only when the ignition is turned on.

Information on the display

The data will appear on the display similar to how it appears on a printout, although one printout line (24 characters) will be shown divided onto two lines.



Example for the data display

If you page backward with the  /  buttons while paging through the information, you will be able to move backward only about 20 printout lines.

Use the  button to leave the display.

Remark

Calling a function is identical to that of a printout and will not be explained separately. There is also a possibility to access any desired display in local time.

You can display all activities of the selected day or the saved or still active events and faults by paging.

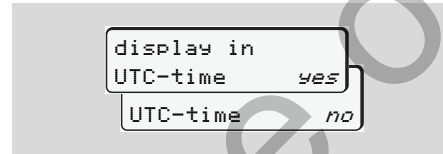

"No" = Display in local time

Select the possible displays for driver 1 or driver 2 step by step.

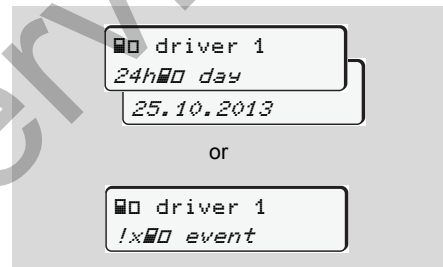

■ Main menu display vehicle

From this main menu you can display data from the data memory.

 In the ADR variant *, the data can be displayed only when the ignition is turned on.

Information on the display

The data will appear on the display similar to how it appears on a printout, although one printout line (24 characters) will be shown divided onto two lines.





```

▼ 23.10.2013 14:
55 (UTC)
-----▼-----
-----
  
```



Example for the data display

If you page backward with the  /  buttons while paging through the information, you will be able to move backward only about 20 printout lines.

Use the  button to leave the display.

Remark

Calling a function is identical to that of a printout and will not be explained separately. There is also a possibility to access any desired display in local time.

Or

- Display the number of the company card of the registered company. If no company is registered, then "____" will appear.

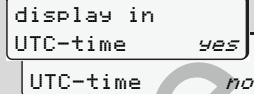

```

display in
UTC-time  yes
-----
UTC-time  no
  
```

"No" = Display in local time

Select the possible functions step by step.

By paging, you can:

- Display all driver activities in chronological order.
- Display of all saved or still active events and faults.
- Display the instances when the set overspeed was exceeded.
- Display data about vehicle identification, sensor identification, and calibration.

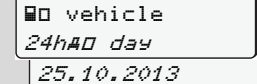

```

▣▣ vehicle
24h day
-----
25.10.2013
  
```

or

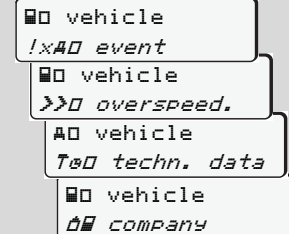

```

▣▣ vehicle
!x day event
▣▣ vehicle
>> overspeed.
▣▣ vehicle
T day techn. data
▣▣ vehicle
▣▣ company
  
```

Messages

A message appears

Overview of the events

Overview of the faults

Driving time warning

Overview of the operational notes

Service Only

0

■ A message appears

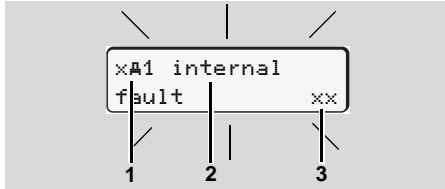

Display of a message

- (1) Pictogram combination, if necessary, with card slot number
- (2) Plain text of the message
- (3) Memory code



Risk of Accident

While driving, messages can appear in the display. It is also possible that the driver card will be automatically ejected due to a security breach.

Do not be distracted by this; instead, continue to focus all of your attention on driving safely.

7

The DTCO 1381 permanently records the driver-based and vehicle-based data and monitors the system's functions. Errors in a component, in the device, or in the operating procedure will be displayed immediately after occurrence and are divided functionally into the following groups:

- ! = Event
- x = Fault
- ⚠ = Driving time warning
- ⓘ = Operational notes



During card-based messages, the card slot number will appear in addition to the pictogram.

► Characteristics of the messages

Events, faults

- The display's backlighting flashes for approximately 30 seconds. At the same time, the cause of the fault appears with a pictogram combination,

plain text of the message, and memory code.

- You must acknowledge these messages using button **OK**.
- The DTCO 1381 also saves (in the driver card's data memory) data related to the event or the fault in accordance with the memory regulations contained in the directive. You can display or print this data through the menu function.

Driving time warnings

- This message warns the driver about excessive driving times.
- The message is backlighted and must be confirmed by means of button **OK**.

Operational notes

Operational notes are displayed without flashing backlighting and (with the exception of some messages) disappear automatically after 3 or 30 seconds.





Instrument display

If an instrument display is built into the vehicle, the functional monitoring "T" will refer to messages on the DTCO 1381.

 For detailed information refer to the vehicle's operating instructions.

► Acknowledgement of messages

1. If you press the button , the flashing of the backlighting will stop immediately.
2. Press the button  again, the message disappears and the standard display (a), (b) or (c) will appear again.

Remark

The operational note disappears when pressing the button  for the first time.



- If you do not acknowledge a message while driving, the message will appear every ten seconds alternately with the currently set standard display.
- If several messages are pending, then you must acknowledge the individual messages one after the other.



If the tachograph fails to operate properly, you (as driver) will be responsible to note information about the activities which will no longer be properly recorded or printed by the tachograph on a separate sheet or on the rear side of the paper roll!

➔ Refer to "Handwritten activity entries" on page 36.

■ Overview of the events



If an event repeats on a continuous basis, please contact an authorised workshop.

Picto / reason	Meaning	Measure
!Ⓜ security breach	<p>The following are possible causes:</p> <ul style="list-style-type: none"> • Error in the data memory, data security in the DTCO 1381 is no longer ensured. • The data from the sensor are no longer reliable. • The DTCO 1381 housing was opened without authorisation. 	Acknowledge message.
!Ⓜ1 security breach	<ul style="list-style-type: none"> • The card lock is disturbed or defective. • The DTCO 1381 no longer detects a tachograph card that was previously inserted correctly. • The identity or authenticity of the tachograph card is not proper or the data recorded on the tachograph card is not reliable. 	<p>Acknowledge message.</p> <p>If the DTCO 1381 recognises security breaches which do no longer ensure the correctness of the data on the tachograph card, the tachograph card is automatically ejected (even while the vehicle is moving)! Insert tachograph card once again or have it checked if necessary.</p>
!⚡ power interruption	The power was disconnected or the power supplied to the DTCO 1381 / sensor was too low or too high. Under certain conditions this message can also appear when the engine starts!	<p>Acknowledge message.</p> <p>➡ Refer to “Power interruption” on page 20.</p>
!Ⓜ sensor fault	The communication with the sensor is interrupted.	Acknowledge message.
!Ⓜ motion conflict	Contradiction in the evaluation of the vehicle movement between sensor and an independent signal source. Perhaps the function (ferry/train) was not set during the transport.	<p>Acknowledge message.</p> <p>Contact an authorised workshop as soon as possible.</p>

Picto / reason	Meaning	Measure
!🚗 driving without card	Driving commenced without a driver card or without a valid driver card in card slot 1. The message also appears if a non-permissible card combination is caused by inserting the card while the vehicle is moving. ➔ Refer to "Operating modes of the DTCO 1381" on page 78.	Acknowledge message. Stop vehicle and insert valid driver card. Withdraw a possibly inserted company card / control card from the DTCO 1381.
!🚗01 insertion while driving	The driver card was inserted after driving has begun.	Acknowledge message.
!🕒01 time overlap	The set UTC time of this tachograph is behind the UTC time of the previous tachograph. This produces a negative time difference.	Acknowledge message. Determine the tachograph with the incorrect UTC time and make sure that an authorised workshop checks and corrects the tachograph as soon as possible.
!🚗1 card not valid	The tachograph card has either expired, is not yet valid, or the authentication has failed. An inserted driver card which has become invalid after a change of day will be automatically written to and ejected (without request) after the vehicle becomes stationary.	Acknowledge message. Check tachograph card and insert it again.
!🚗🚗 cards conflict	The two tachograph cards must not be inserted together in the DTCO 1381! For example, the company card is inserted together with a control card.	Acknowledge message. Remove the corresponding tachograph card from the card slot.
!🚗A1 card not closed	The driver card was not properly removed from the last tachograph. In some cases driver-based data will not be saved.	Acknowledge message.
>> overspeed	The set maximum speed was exceeded for longer than 60 seconds.	Acknowledge message. Reduce speed.

■ Overview of the faults

 **If a fault repeats on a continuous basis, please contact an authorised workshop.**

<i>Picto / reason</i>	<i>Meaning</i>	<i>Measure</i>
x⚠ internal fault	Serious fault in the DTCO 1381, the following are possible causes: <ul style="list-style-type: none"> • Unexpected program faults or processing time faults. 	Acknowledge message.
	<ul style="list-style-type: none"> • Button elements blocked or pressed simultaneously for some time. 	Check proper function of the button elements.
	<ul style="list-style-type: none"> • Communication fault with external devices. 	Check connecting cables or function of the external devices.
	<ul style="list-style-type: none"> • Communication fault with the instrument display. 	Check connecting cables or function of the instrument display.
	<ul style="list-style-type: none"> • Fault at pulse output. 	Check connecting cables or function of the connected control device.
x⚠1 internal fault	<ul style="list-style-type: none"> • Fault in the card mechanics, e.g. card lock is not closed. 	Remove tachograph card and insert it again.
x⚠ time fault	UTC time of the DTCO 1381 is not plausible or does not function properly. In order to avoid an inconsistency of data, newly inserted driver / company cards are not accepted!	Acknowledge message.
x⚠ printer fault	The printer's supply voltage has failed or the temperature sensor for the printing head is defective.	Acknowledge message. Repeat the process and, if necessary, switch off / on the ignition again.

Picto / reason	Meaning	Measure
x↓ download fault	Fault while downloading the data to an external device.	Acknowledge message. Repeat the data download once again. Check connecting cables (e.g. loose contact) or external device.
x⏏ sensor fault	The sensor has indicated an internal fault after a self-test.	Acknowledge message.
x⏏ IMS fault	IMS = Independent Motion Signal. The additional independent motion signal is missing or is not available.	Acknowledge message.
x⏏1 card fault	A communication fault has appeared while reading / writing the tachograph card, e.g. by dirty contacts.	Acknowledge message. Clean the contacts of the tachograph card and insert it again.
x⏏2 card fault	It might not be possible to record the data completely on the driver card!	➔ Refer to "Disposal of the components" on page 83.

■ Driving time warnings

<i>Picto / reason</i>	<i>Meaning</i>	<i>Measure</i>
! break! 1e04h15 #00h15	This message appears after an uninterrupted driving time of 4 hours 15 minutes.	Acknowledge message. Please plan a rest break soon.
! break! 1e04h30 #00h15	Driving time exceeded! This message appears after an interrupted driving time of 4 hours 30 minutes.	Acknowledge message. Please take a rest break.



Please note!

The DTCO 1381 registers, saves and calculates the driving times on the basis of the rules established by the EU regulations. It warns the driver prematurely about exceeding his driving time!

However, these cumulative driving times do not anticipate the legal interpretation of "continuous driving time".

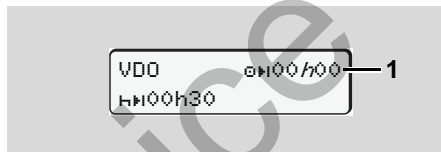

► VDO Counter * display



After having acknowledged the second "Driving time warning", the VDO Counter * displays your driving time (1) has ended (except for Out of Scope operation).

Please take a rest break at once.

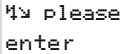
■ Overview of the operational notes

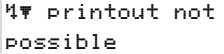
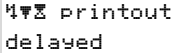
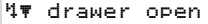
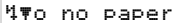
<i>Picto / reason</i>	<i>Meaning</i>	<i>Measure</i>
 please enter	This request will appear if no entry is made during the manual entry procedure.	Press button  and continue the entry.
 printout not possible	A printout is not possible at the moment: <ul style="list-style-type: none"> because the ignition has been switched off (ADR variant *). because the temperature of the thermal printing head is too high, the printer interface is occupied by another active process, e.g. a printout in progress, or because the supply voltage is too high or too low. No display is possible at the moment since the ignition has been switched off (ADR variant *). 	You can request a printout as soon as the problem is removed. Switch on ignition and call the desired display again.
 printout delayed	An ongoing printout is interrupted or delayed because the temperature of the thermal printing head is too high.	Wait to cool. The printout will continue automatically as soon as the permissible condition has been reached.
 drawer open	When a printout is requested or a printout is in progress, the DTCO 1381 recognises that the printer drawer is open. The print request will be rejected and/or a printout in progress will be interrupted. This message also appears if you request the tachograph card from card slot 2 while the printer drawer is open.	Close the drawer. Restart print request. Close printer drawer and request tachograph card again.
 no paper	The printer has no paper. The print request will be rejected and/or a printout in progress will be interrupted.	If a new roll of paper is inserted within one hour, the DTCO 1381 automatically continues the printout.



<i>Picto / reason</i>	<i>Meaning</i>	<i>Measure</i>
4E Ejection not possible	Requesting the tachograph card will be rejected: <ul style="list-style-type: none"> because data might be read in or transferred, the driver card needs to be read-in again within the registration time of one minute, a day change (according to UTC time) is taking place, the vehicle is moving, or, in the ADR variant *, the ignition has been switched off. 	Wait until the DTCO 1381 enables the function or remove the problem: Stop the vehicle or switch on the ignition. Then request the tachograph card again.
4E?1 recording inconsistent	There is an inconsistency in the order of the dates in the data recorded on the driver card.	This message can be displayed until the incorrect recordings have been overwritten by new data! Have the tachograph card checked if the message is displayed permanently.
4E1 card error	An error has occurred when processing the inserted tachograph card. The tachograph card is not accepted and is ejected.	Clean the contacts of the tachograph card and insert it again. If this message is displayed again, check whether another tachograph card can be read in correctly.
4E1 wrong card type	The inserted card is not a tachograph card. The card is not accepted and is ejected.	Please insert a valid tachograph card.
4A1 internal fault	Fault in the card mechanics, e.g. card lock is not closed.	Remove tachograph card and insert it again.
4A internal fault	<ul style="list-style-type: none"> Fault at pulse output. 	Check connecting cables or function of the connected control device.

Picto / reason	Meaning	Measure
	<ul style="list-style-type: none"> The DTCO 1381 has a serious fault or a serious time error has occurred. For example, an unrealistic UTC time. The tachograph card is not accepted and is ejected. 	Take care that an authorised workshop checks and, if necessary, replaces the tachograph as soon as possible.
continual error #xxxxxxxx xxx	If this message is displayed, the DTCO 1381 will no longer function!	Please observe the listed note if the tachograph does not operate properly, ➔ see page 67.

Operational notes as information

Picto / Reason	Meaning	Measure
■ no data!	The menu function cannot be called up since, in the card slot, ... <ul style="list-style-type: none"> no driver card is inserted or a company card / control card is inserted. 	These notes disappear automatically after three seconds. No steps must be taken.
⊖ UTC correct. impossible!	It is not possible to use the menu function: <ul style="list-style-type: none"> The UTC time has already been corrected within the last seven days. You are trying to correct the UTC time between one minute before and one minute after midnight. 	
printout started ...	Acknowledgement of the selected function.	
entry stored	Acknowledgement that the DTCO 1381 saved the entry.	
display not possible!	No data can be displayed as long as the printing is in progress.	
please wait!	The tachograph card has not yet been read completely. It is not possible to call up menu functions.	



Picto / Reason	Meaning	Measure
<p>⚠️ calibration in days 18</p>	<p>The next periodic inspection is due, for example in 18 days. Inspections required due to technical alterations cannot be taken into account! An authorised workshop can program when the notice should start to appear. ➡ <i>For more details, see “Compulsory Tachograph inspections” from page 83.</i></p>	<p>These notes disappear automatically after three seconds. No steps must be taken.</p>
<p>⚠️ expires in days 15</p>	<p>The released tachograph card, for example, expires in 15 days! An authorised workshop can program the day as of which the notice should appear.</p>	
<p>⚠️ preuzeti u danima 7</p>	<p>From Release 2.1: The next download of the driver card will, for example, be due in 7 days (default setting). An authorised workshop can program when the notice should start to appear.</p>	

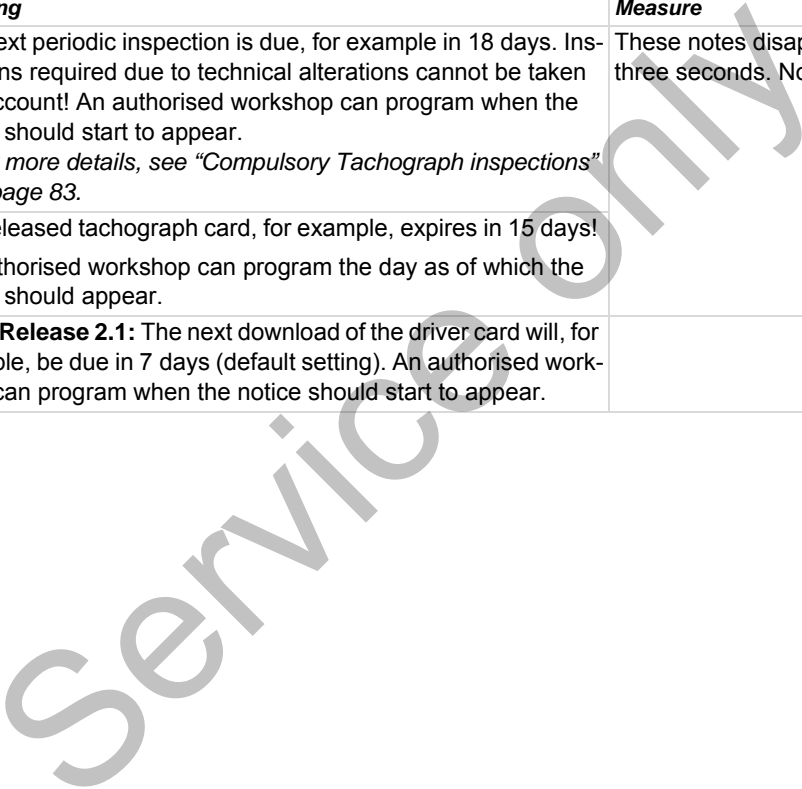

Product description

Operating modes of the DTCO 1381

Tachograph cards

Saved data

Time management

Care and maintenance

Technical data

Service Only

■ Operating modes of the DTCO 1381

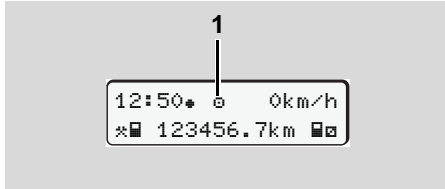

The DTCO 1381 has four operating modes:

- Operational "O"
- Company "C"
- Control "K"
- Calibration "T"

According to the inserted tachograph card(s), the DTCO 1381 automatically changes to the following operating mode:

(1) Display of the operating mode

Operating modes		Card slot -1				
		No card	Driver card	Company card	Control card	Workshop card
Card slot -2	No card	Operational	Operational	Company	Control	Calibration
	Driver card	Operational	Operational	Company	Control	Calibration
	Company card	Company	Company	Company	Operational	Operational
	Control card	Control	Control	Operational	Control	Operational
	Workshop card	Calibration	Calibration	Operational	Operational	Calibration

In this condition, the DTCO 1381 only uses the tachograph card inserted in card slot 1.

■ Tachograph cards

The authorities in the individual EU member states will issue the tachograph cards specified by the legislature.

▶ Driver card

The driver uses the driver card to identify himself to the DTCCO 1381. The driver card is used for normal driving operation and permits storing, displaying, printing, or downloading (with only one inserted driver card) of activities under this identity.

▶ Company card

The company card identifies a company and authorises access to the data of this company. With the company card, the data saved in the data memory of the Vehicle Unit as well as in the inserted driver card can be displayed, printed, and downloaded. If necessary (once per unit), the entry of the authorising member state and the official registration number in the DTCCO 1381.

It is also possible to download load data remotely with the corresponding fleet management system. This company card

is intended for the owners and operators of vehicles.

▶ Control card

The control card identifies an official of a control body (like the police) and permits access to the data in the data memory. All saved data and the data of an inserted driver card are accessible. This data can be displayed, printed, or downloaded through the download interface.

▶ Workshop card

Persons of an authorised workshop who are approved to program, calibrate, activate, test, etc. will receive the workshop card.

▶ Locking the tachograph cards

If the DTCCO 1381 accepts an inserted tachograph card, removal of the card will be mechanically blocked. It is possible to remove the tachograph card only when:

- the vehicle is stationary,
- the user requests removal,

- after the data defined by the regulations has been saved on the tachograph card.

Automatic ejection

If the DTCCO 1381 recognises a fault in the card lock, it tries to transfer the existing data to the tachograph card before it is automatically ejected. In this case, the completeness and authenticity of the data on the tachograph card can no longer be guaranteed!

► Access rights of the tachograph cards

The rights to access data saved in the data memory of the DTCO 1381 are regulated by law and will be released with the corresponding tachograph card only.

		Without card	Driver card	Company card	Control card	Workshop card
Print	Driver data	X	V	V	V	V
	Vehicle data	T1	T2	T3	V	V
	Parameter data	V	V	V	V	V
Displays	Driver data	X	V	V	V	V
	Vehicle data	T1	T2	T3	V	V
	Parameter data	V	V	V	V	V
Read out	Driver data	X	T2	V	V	V
	Vehicle data	X	X	T3	V	V
	Parameter data	X	X	V	V	V

Driver data = Data on the driver card

Vehicle data = Data in the data memory

Parameter data = Data for device adaptation / Calibration

V = Unlimited access rights

T1 = Driver activities of the last eight days without driver identification data

T2 = Driver identification only for the inserted card

T3 = The associated company's driver activities

X = not possible

■ Saved data

► Driver card

- Data for identifying the driver.

After any use of the vehicle the following data:

- Vehicles used
- Activities of the driver, during normal driving operation at least 28 days.
- Country entries
- Appearing events / faults
- Information about control activities
- Specific conditions including Out of Scope and ferry / train operations

If the memory capacity is full, the oldest data will be overwritten by the DTCO 1381.

► Company card

- Identifies a company and authorises access to the data of this company.

The following data regarding company activities:

- Type of activity
 - Lock-in / lock-out

- Downloading the data from the data memory
- Downloading the data from the driver card

- Period of time (from / to) for which the data was downloaded.
- Vehicle ID
- Driver Card number and card issuing Member State (when downloading a Driver Card)

► Data memory

- The data memory records and saves the data required according to the Council Regulation (EEC) 3821/85, annex I B, over a time period of at least 365 calendar days:
 - The evaluation of activities occurs in 1 minute intervals and the DTCO 1381 will evaluate the longest continuous activity for each interval.
 - Speed values are saved over a time period of 168 hours at a resolution of 1 second. The DTCO 1381 saves each

second of the driven speed with date and time.

- Saved speed values with a higher resolution (one minute before and one minute after an unusual deceleration) can be analysed in the event of a collision.

These data can be read via the download interface:

- legal download 24 hours,
- the complete mass memory by means of special download software.

► VDO GeoLoc * (from Release 2.1)

The recording of vehicle position data via GPS is possible as an option. ➔ Refer to "VDO GeoLoc * (from Release 2.1)" on page 17.

■ Time management

The DTCO 1381 saves all time entries for working time, availability time, driving time, rest time, etc. in UTC time.

➔ Time zone "0" = UTC

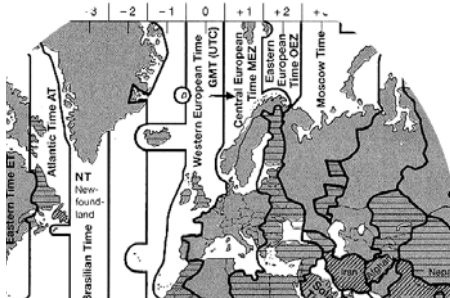

Time zone in Europe

8 UTC time corresponds to time zone "0" of the 24 time zones (-12 ... 0 ... +12) distributed across the globe.

In principle, the time shown in the display is set at the factory in UTC time. You can set the local time through the menu function.

➔ Refer to "Set Local time" on page 61.

Time zone offset	Countries
00:00 (UTC)	UK / P / IRL / IS
+ 01:00 h	A / B / BIH / CZ / D / DK / E / F / H / HR / I / L / M / N / NL / PL / S / SK / SLO / SRB
+ 02:00 h	BG / CY / EST / FIN / GR / LT / LV / RO / TR / UA
+ 03:00 h	RUS

▶ Converting to UTC time

UTC time = Local time – (ZO + SO)

ZO = Time zone offset

SO = Daylight-savings time offset

(this offset is not used after daylight-savings time ends)

(ZO + SO) = set offset in the DTCO 1381

Example:

Local time in Germany = 15:30
(daylight-savings time)

UTC time = Local time – (ZO + SO)
= 15:30 –
(01:00 h + 01:00 h)

UTC time = 13:30 Time

■ Care and maintenance

► Cleaning the DTCO 1381

Clean the casing, the display and the function keys with a slightly moistened cloth or with a microfibre cleaning cloth.



Do not use any abrasive cleaning agents or solvents like thinner or petroleum spirits.

► Compulsory Tachograph inspections

Preventive maintenance work is not required for the DTCO 1381. At least every two years, the proper operation of the DTCO 1381 must be checked by an authorised workshop.

Follow-up inspections are necessary if

- changes were made to the vehicle, e.g. concerning the distance pulse or the wheel circumference,
- a repair was made to the DTCO 1381,
- the vehicle registration number of the vehicle has been changed,

- the UTC time deviates by more than 20 minutes.



Make sure that the calibration plaque is renewed during every 2 year inspection and contains the required data.

Make sure that the supply voltage of the DTCO 1381 is not disconnected for more than 12 months at a time, for example due to disconnection of the battery from the vehicle.

► Behaviour when repairing / replacing the DTCO 1381

The authorised workshops can download the data from the DTCO 1381 and hand them over to the company.

If, due to a failure, the saved data cannot be downloaded, the workshops are instructed to document this with a certificate and to contact the company in writing.



Archive the data or carefully keep the documentation for possible requests by control bodies.

► Disposal of the components



Please dispose of the DTCO 1381 with its associated system components in compliance with the guidelines for disposing EC recording equipment effective in the respective member states.

■ Technical data

► DTCO 1381

Measurement range end value	220 km/h (according to annex I B) 250 km/h (for other vehicle deployments)	
LCD	2 lines with 16 characters each	
Temperature	Operation:	-25 to 70 °C
	Storage:	-40 to 85 °C
Voltage	24 or 12 Volt DC	
Power supply	Standby:	Typical during oper.:
	max. 30 mA (12 V)	max. 3,0 A (12 V)
	max. 20 mA (24 V)	max. 1,0 A (24 V)
EMV / EMC	ECE R10	
Thermal printing mechanism	Character size:	2,1 x 1,5 mm
	Print width:	24 characters/line
	Speed:	appr. 15-30 mm/sec.
	Printout of diagrams	
Protection type	IP 54	

Possible special equipment

- ADR variant
- Customer-specific panel, illumination of display and buttons
- Automatic setting of the activities after ignition on/off
- Printout and download of v-/n profiles, status entry D1/D2
- VDO Counter
- VDO GeoLoc (from Release 2.1)

► Paper roll

Ambient conditions	Temperature:	-25 to 70 °C
Dimensions	Diameter:	approx. 27.5 mm
	Width:	56,5 mm
	Length:	approx. 8 m
Order no.	1381.90030300	
	You will receive original spare paper rolls from your local VDO distributor.	

 **Please note!**

Use (order) only paper rolls (original VDO printer paper) on which is visible the tachograph model (DTCO 1381) with approval mark "E184" and the valid approval mark "E174" or "E189".

Pictograms and printout samples

Overview of the pictograms

Country symbols

Printout examples

Explanation of printout examples

Data record purpose during events or faults

Service only

■ Overview of the pictograms

Operating modes

🏢	Company
🔧	Control
⚙️	Operational
📏	Calibration
📅	Production status

Persons

🏢	Company
🔧	Controller
👤	Driver
📏	Workshop / inspection centre
📅	Manufacturer

Activities

🕒	Availability time
⌚	Driving time
🛑	Break and rest time
⌘	Other working time
⏸️	Valid interruption / break
❓	Unknown

Devices / functions

1	Card slot 1; Driver 1
2	Card slot 2; Driver 2
📄	Tachograph card (read correctly)
—	Tachograph card inserted; relevant data read.
🕒	Clock
🖨️	Printer / printout
👤	Entry
📺	Display
📍	VDO GeoLoc * is switched on. (from Release 2.1)
📄	External saving Download data (copy)
📡	Data transmission running
📡	Sensor
🚗	Vehicle / Vehicle unit / DTCO 1381
🛞	Tyre size
🔌	Power supply

Miscellaneous

!	Event
×	Fault

📄	Operational note / Work time warnings
🕒	Shift beginning
📍	Location
🔒	Security
➡️	Speed
🕒	Time
Σ	Total / summary
🕒	Shift end
📄	Manual entry of driver activities

Specific conditions

OUT	Recording equipment not required
🚢	Vehicle located on a ferry or on a train

Qualifiers

24h	Daily
I	Weekly
II	Two weeks
➡️	From or to

► Pictogram combinations

Miscellaneous	
	Control location
	Start time
	End time
	Begin Out of Scope: Recording equipment not required
	End Out of Scope
	Location at beginning of work day (shift beginning)
	Location at end of work day (shift end)
	From vehicle
	Printout driver card
	Printout vehicle / DTCO 1381
	Entry vehicle / DTCO 1381
	Display driver card
	Display vehicle / DTCO 1381
	Local time
	UTC correction

Cards	
	Driver card
	Company card
	Control card
	Workshop card
	No card

Driving	
	Crew
	Driving time over two weeks

Printouts	
	Daily driver activities (daily value) from the driver card
	Events and faults from the driver card
	Daily driver activities (daily value) from DTCO 1381
	Events and faults from DTCO 1381
	Over-speeding
	Technical data
	Driver's activities
	v-diagram
	Status D1/D2 diagram *

	Speed profiles *
	Rpm profiles *

Displays	
	Daily driver activities (daily value) from the driver card
	Events and faults from the driver card
	Daily driver activities (daily value) from vehicle / DTCO 1381
	Events and faults from vehicle / DTCO 1381
	Over-speeding
	Technical data
	Company

Events	
!	Insertion of an invalid tachograph card
!	Time overlap
!	Insertion of driver card while driving
>>	Over-speeding
!	Communication fault with the sensor
!	Time adjustment (by workshop)
!	Cards conflict
!	Driving without valid driver card
!	Last card process not completed correctly
!	Interruption of power supply
!	Security breach
>	Over-speeding control
!	Motion data conflict during vehicle movement

Faults	
×	Card fault
×	Display fault
×	Printer fault
×	Internal fault DTCO 1381
×	Download fault
×	Sensor fault
×	IMS = Independent motion signal missing

Driving time warnings

	break!
--	--------

Manual entry process

	Entering "activities"
?	Entering "unknown activity"
	Entering "location" at the end of the shift
	Entering "location" at the beginning of the shift

Operational notes

	Wrong entry
	Menu access not possible
	Please enter
	Printout not possible

	Drawer open
	No paper
	Printout delayed
	Card defective
	Incorrect card
	Ejection not possible
	Process delayed
	Recording inconsistent
	Internal fault
	Expires in days ...
	Calibration in days ...
	Download of driver card in days ... (from Release 2.1)

VDO Counter *

	Remaining driving time
	Beginning of the next driving time
	Release 2.0
	Release 2.1
	Future driving time
	Release 2.0
	Release 2.1
	Remaining break time / rest period
	Remaining time until the beginning of the daily, weekly rest period

■ Country symbols

Value assignment	
A	Austria
AL	Albania
AND	Andorra
ARM	Armenia
AZ	Azerbaijan
B	Belgium
BG	Bulgaria
BIH	Bosnia and Herzegovina
BY	Belarus
CH	Switzerland
CY	Cyprus
CZ	The Czech Republic
D	Germany
DK	Denmark
E	Spain ¹⁾
EC	European Community
EST	Estonia
EUR	Rest of Europe
F	France
FIN	Finland
FL	Liechtenstein

FR/FD	Faroes
GE	Georgia
GR	Greece
H	Hungary
HR	Croatia
I	Italy
IRL	Ireland
IS	Iceland
KZ	Kazachstan
L	Luxembourg
LT	Lithuania
LV	Latvia
M	Malta
MC	Monaco
MD	Republic of Moldavia
MK	Macedonia
MNE	Montenegro
N	Norway
NL	The Netherlands
P	Portugal
PL	Poland
RO	Romania

RSM	San Marino
RUS	The Russian Federation
S	Sweden
SK	Slovakia
SLO	Slovenia
SRB	Serbia
TM	Turkmenistan
TR	Turkey
UA	Ukraine
UK	United Kingdom, Alderney, Guernsey, Jersey, Isle of Man, Gibraltar
UZ	Uzbekistan
V	Vatican City
WLD	Rest of the world

1) ➔ Refer to “Symbols of the regions” on page 90.

► Symbols of the regions

Value assignment – Spain

AN	Andalusia
AR	Aragon
AST	Asturias
C	Cantabria
CAT	Catalonia
CL	Castile-León
CM	Castile-La Mancha
CV	Valencia
EXT	Extremadura
G	Galicia
IB	Balearic islands
IC	Canary islands
LR	La Rioja
M	Madrid
MU	Murcia
NA	Navarra
PV	Basque Community

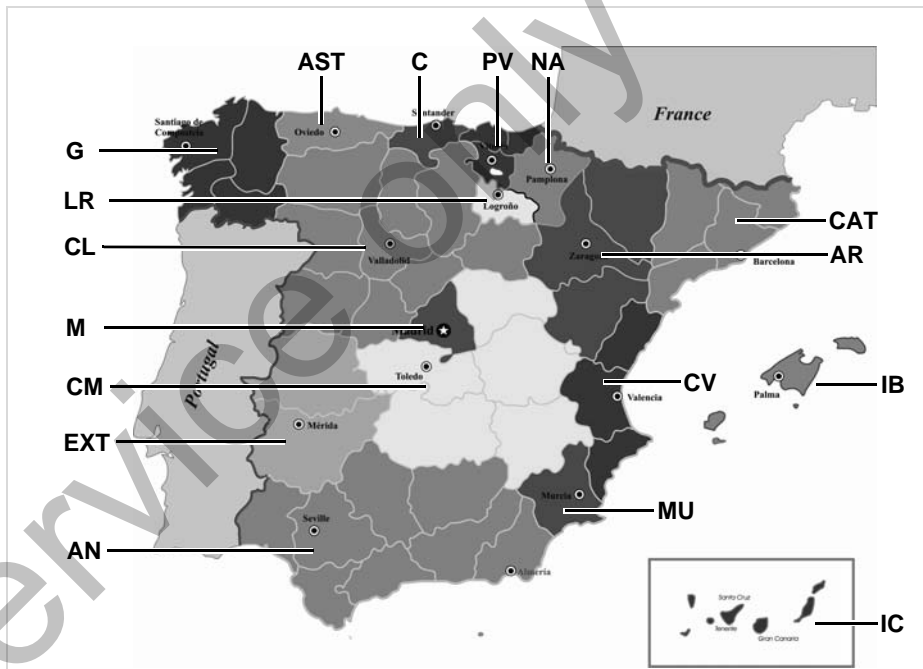

■ Printout examples

► Daily printout from the driver card

Sample 1 (Left):

- 1: 26.11.2013 14:55 (UTC)
- 2: 24h
- 3: Schmitt Peter
- 3a: /12345678901234 5 6
- 4: ABC12345678901234 D /VS VM 612
- 5: Continental Automotive GmbH 1381.12345678901
- 6: NFZ-Profi Service & Vertrieb 02.04.2012
- 7: /12345678901234 5 6
- 8: 11.11.2013 11:11
- 8a: 25.11.2013 310
- 8b: A D /VS VM 612 95 872 km

Sample 2 (Middle):

- 8c: * 06:17 00h45
- 8e: * 07:02 00h39 95 958 km; 86 km
- 8a: ? 09:00 00h24
- 8b: A S /LCR 243 205 002 km
- 8c: * 09:24 02h30 11:54 00h39
- 8a: ? 12:33 00h10
- 8c: * 12:43 02h27 15:10 01h12 16:22 00h16 16:38 00h42 18:38
- 8d: 18:38
- 8e: * 17:20 00h52 18:12 00h24 18:36 00h02 205 408 km; 231 km
- 8a: ? 18:38 05h22
- 11: * 06:00 D 95 872 km
- 11a: * 09:00 D 95 958 km * 09:24 D 205 002 km * 12:33 D 205 177 km * 12:43 D 205 177 km

Sample 3 (Right):

- 11d: * 18:38 CH 205 408 km * 04h54 317 km * 02h27 03h29 01h14 ? 11h56 00h28
- 12: * 0 10.11.2013 12:45 00h04 A D /VS VM 612
- 12c: ! 0 05.08.2013 09:23 !34 (0) 00h01 A D /VS VM 612
- 13: A D /VS VM 612 * 5 15.11.2013 16:42 (2) 00h12 * 98765432109876 5 4 * 12345678901234 5 6
- 13c: * 4 15.10.2013 11:10 (95) 00h30 * 45678901234567 7 8 * 12345678901234 5 6 * 0 10.11.2013 12:45 00h04 * 45678901234567 7 8
- 21: Friedrichshafen Schmitt Peter Rosenz Winfried

Points to note with "Daily printout of the driver card"

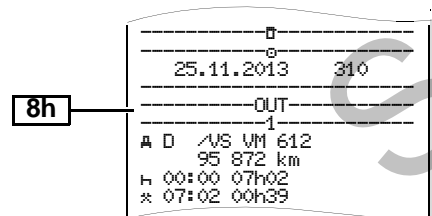
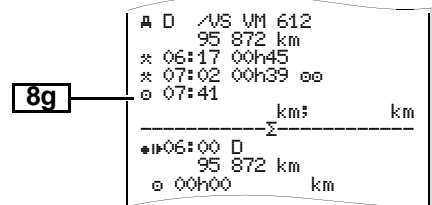
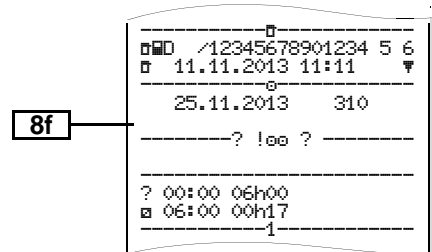

► Events / faults from the driver card

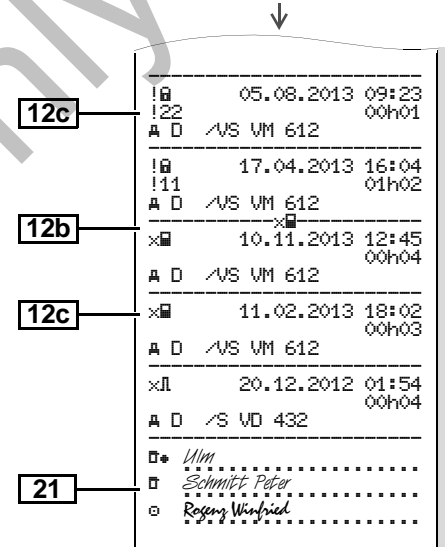
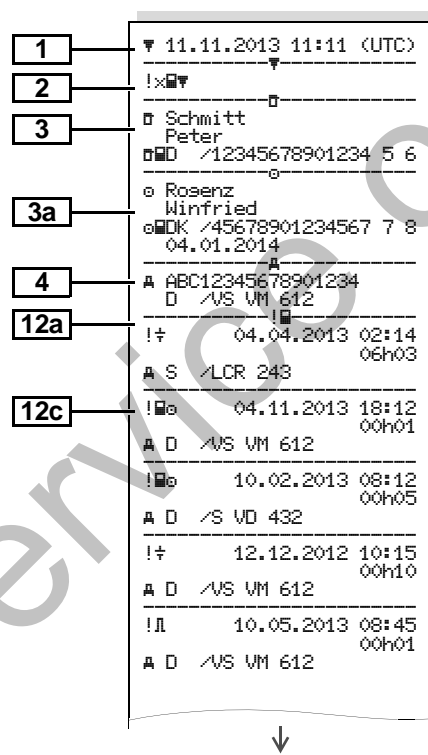

► Daily printout of the vehicle

1	▼ 27.11.2013 16:55 (UTC)
2	24hA▼
3	□ Schmitt Peter □ID /12345678901234 5 6
4	A ABC12345678901234 D /VS VM 612
5	□ Continental Automotive GmbH 1381.12345678901
6	T NFZ-Profi Service & Ve rtrieb TID /87654321087654 3 2 T 02.04.2012
7	□ID /12345678901234 5 6 □ 11.11.2013 11:11
9	25.11.2013 95 872 - 96 284 km
10	-----1-----
10a	□----- H 95 872 km 00:00 06h17 0 km 95 872 km
10b	□ Rosenz Winfried □DK /45678901234567 7 8 04.01.2014
10c	A+S /LCR 243 24.11.2013 18:54
10d	95 872 km M

10e	* 06:17 00h45 * 07:02 00h39 □□ □ 07:41 01h19 □□ 95 958 km 86 km
10g	□-----
10a	95 958 km * 09:00 00h05 95 958 km 0 km
10b	□ Mustermann Heinz-Dieter □F /12345678901234 5 6 16.06.2013
10c	A+D /M MS 680 24.11.2013 18:54
10d	95 958 km
10f	* 09:05 00h25 * 09:30 02h55 □ 12:25 01h18 12:25 □-----
10e	□ 13:43 00h03 * 13:46 00h02 □□ * 13:48 00h45 □□ * 14:33 00h35 □□ H 15:08 01h02 □□ 96 206 km 248 km
10g	□----- 96 206 km H 16:10 00h20 96 206 km 0 km
	□ Anton Max □A /56789567895678 9 5 25.10.2013

	A+D /VS VM 612 25.11.2013 16:30 96 206 km □ 16:30 00h56 * 17:26 01h11 96 274 km 68 km
10a	□----- 96 274 km * 18:37 00h23 □ 19:00 00h21 H 19:21 04h39 96 284 km 10 km -----2-----
10h	□----- 95 872 km H 00:00 07h02 H 00:00 07h02
10a	□-----
11	-----Σ-----
11b	1□----- □ 00h21 10 km * 00h28 □ 00h00 H 11h16
11c	2□----- * 00h00 □ 12h16 H 07h02
11e	□ Rosenz Winfried □DK /45678901234567 7 8 H*09:00 D 95 958 km □ 01h19 86 km * 01h24 □ 00h00 H 00h00 □□ 01h58

↓

13 !xA
!e 1 25.11.2013 19:01
(1) 00:20

13c >> 5 15.11.2013 16:42
(2) 00h12
e /98765432109876 5 4
e /12345678901234 5 6

x 0 10.11.2013 12:45
00h04
e /45678901234567 7 8

21 Lindau
Schmitt Peter

Points to note with "Daily printout of the vehicle"

10i 1
OUT

e Rosenz
Winfried
e /45678901234567 7 8
04.01.2014
A+S /LCR 243

► Events / faults from the vehicle

1 ▼ 24.10.2013 16:07 (UTC)

2 !xA

3 Schmitt
Peter
e /12345678901234 5 6

4 A ABC12345678901234
D /VS VM 612

13a ! 0 10.08.2013 08:12
(0) 00h01
e /12345678901234 5 6
e /12345678901234 5 6

13c ! 0 10.08.2013 08:20
(0) 00h03
e /12345678901234 5 6
e /12345678901234 5 6

!e 1 15.10.2013 07:02
(1) 00h54

!e 2 15.10.2013 07:02
(1) 00h54

!e 3 15.03.2012 07:56
(1) 00h01
e /12345678901234 5 6
e /22335578901234 1 2

>> 4 15.10.2013 11:10
(95) 00h30
e /45678901234567 7 8
e /12345678901234 5 6

↓

↓

13b ! 0 17.04.2013 16:04
117 (0) 01h02
e /45678901234567 7 8
e /12345678901234 5 6
T /54321987654321 9 8

! 0 05.08.2013 09:23
122 (0) 00h01
e /45678901234567 7 8

13c x 0 10.08.2013 07:00
00h02
e /12341234123412 3 4

13c x 0 05.05.2012 07:15
00h14
e /12345678901234 5 6
e /12345678901234 5 6

x 6 05.05.2012 07:15
00h14
e /12345678901234 5 6
e /12345678901234 5 6

x 0 12.09.2013 21:00
00h01

X?? 0 02.06.2013 21:00
00h30
e /12341234123412 3 4

21 Lindau
Schmitt Peter

► Over-speeding

1	▼ 24.10.2013 14:50 (UTC)
2	>>▼ 90 km/h
3	○ Mustermann Heinz-Dieter oMF /12345678901234 5 6 16.06.2013
4	A ABC12345678901234 D /VS VM 612
19	>>13.03.2013 14:15 >>17.04.2013 17:44 (7)
20	>>24.05.2012 14:02 00h06 98 km/h 92 km/h (1)
20c	○ Förster Thomas oMD /98765432109876 5 4 >>(365)
20a	>>15.10.2013 11:10 00h30 98 km/h 95 km/h (95)
	○ Rosenz Winfried oMDK /45678901234567 7 8
20b	>>16.05.2013 17:10 00h15 94 km/h 92 km/h (12)
20c	○ Mustermann Heinz-Dieter oMF /12345678901234 5 6
21	○ ○ ○ Mustermann Heinz

► Technical data

1	▼ 25.10.2013 14:50 (UTC)
2	To▼
3	o Spedition Mustermüller oMD /12341234123412 3 4
3a	○ Mustermann Heinz-Dieter oMF /12345678901234 5 6 16.06.2013
4	A ABC12345678901234 D /VS VM 612
14	B Continental Automotive GmbH H.-Hertz-Str.45 78052 WS-Villingen 1381.12345678901234567 e1-84 12345678 2013 V xxxx 17.04.2013
15	ll 87654321 e1-175 08.03.2012
16	T Fa. Mustermann & NFZ- Hersteller Schillerstr. 10 Muster kirchen
16a	TMD /45678901234567 8 9 21.01.2013
16b	T 08.03.2012 (1) A ABC12345678901234

17	!e 08.03.2012 14:00 e 08.03.2012 15:00
17a	T Fa. Mustermann & NFZ- Hersteller Schillerstr. 10 Muster kirchen TMD /45678901234567 8 9 21.01.2013
	!e 28.08.2012 13:00 e 28.08.2012 13:26
	T Kienzle ARGO GMBH Bismarckstr. 19 Berlin -Stealitz TMD /89012345678901 5 6 19.10.2013
18	! 18.10.2013 06:34 x 30.09.2013 18:15 -B ATTACHMENT-
25	SWUM V xx.xx
26	CAN: 1 Source: speed Gain: 0.00390625 Factor: 0.926
27	CR(EU) No.1266/2009: XX

► Driver's activities

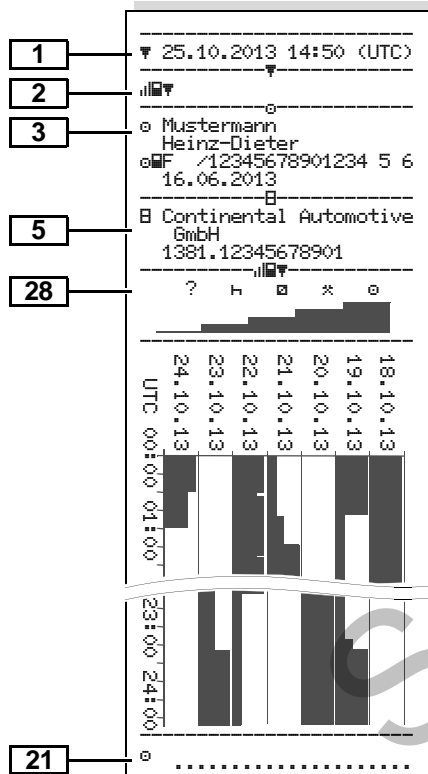

► v-diagram

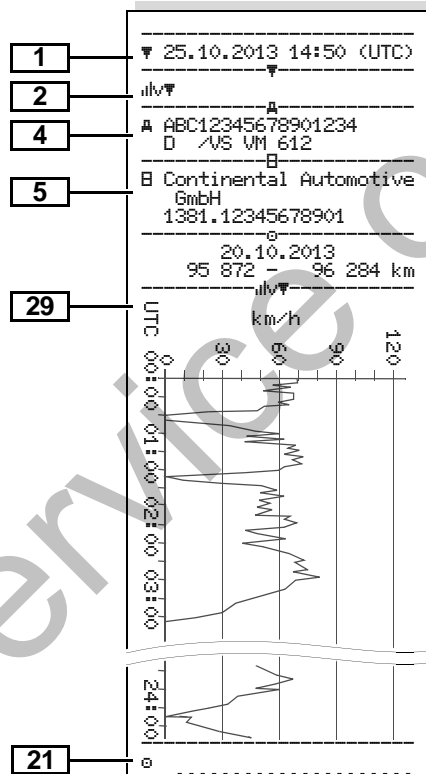

► Status D1/D2 diagram *

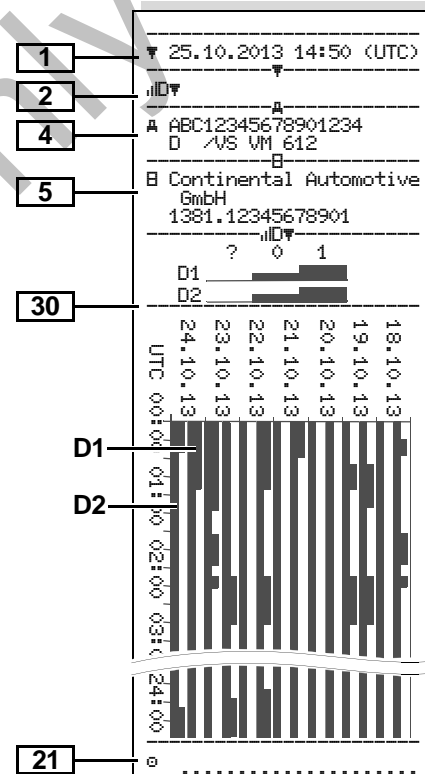

► Speed profiles *

1	▼ 27.11.2013 17:05 (UTC)
2	%v▼
3	♻ Spedition Mustermüller ♻ /12341234123412 3 4
4	A ABC12345678901234 D /VS VM 612
	○ 25.11.2013 00:00 25.11.2013 06:17 --- km/h
22	112 <=v< 221 00h00
	○ Mustermann Heinz-Dieter 25.11.2013 18:37 26.11.2013 00:00
23	--- km/h --- 0 <=v< 1 05h02 1 <=v< 10 00h01 10 <=v< 16 00h02 16 <=v< 24 00h04 24 <=v< 32 00h05 32 <=v< 40 00h05 40 <=v< 48 00h04 48 <=v< 56 00h00 56 <=v< 64 00h00 64 <=v< 72 00h00 72 <=v< 80 00h00 80 <=v< 88 00h00 88 <=v< 96 00h00 96 <=v< 104 00h00 104 <=v< 112 00h00 112 <=v< 221 00h00
21	○

► Rpm profiles *

1	▼ 27.11.2013 17:05 (UTC)
2	%n▼
3	♻ Spedition Mustermüller ♻ /12341234123412 3 4
4	A ABC12345678901234 D /VS VM 612
	○ 25.11.2013 00:00 25.11.2013 06:17 --- rpm
22	3281 <=n< * 00h00
	○ Mustermann Heinz-Dieter 25.11.2013 18:37 26.11.2013 00:00
24	--- rpm --- 0 <=n< 1 05h02 1 <=n< 234 00h00 234 <=n< 469 00h00 469 <=n< 703 00h00 703 <=n< 938 00h00 938 <=n< 1172 00h00 1172 <=n< 1406 00h03 1406 <=n< 1641 00h03 1641 <=n< 1875 00h04 1875 <=n< 2109 00h09 2109 <=n< 2344 00h02 2344 <=n< 2578 00h00 2578 <=n< 2812 00h00 2812 <=n< 3047 00h00 3047 <=n< 3281 00h00 3281 <=n< * 00h00
21	○

► Printout in local time

31	!!! No less! printout!!!
32	⊕+ 25.11.2013 01:00 ⊕+ 26.11.2013 01:00 UTC +01h00
33	▼ 26.11.2013 15:55 (LOC)
34	24h⊕▼
	○ Rosenz Winfried ⊕DK /45678901234567 7 8 04.01.2014
	A ABC12345678901234 D /VS VM 612
	B Continental Automotive GmbH 1381.12345678901
	T NFZ-Profi Service & Ve rtrieb
	TMD /87654321087654 3 2 T 02.04.2012
	♻ /12345678901234 5 6 ♻ 11.11.2013 12:11 ♻

■ Explanations of printout examples

 On request, a company-specific logo can be applied to the printout.

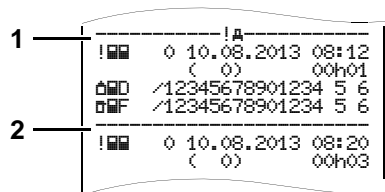

Every printout consists of a string of different data blocks that are identified by block identifiers (1).

A data block contains one or several data records that are identified by means of a data record identifier (2).





A data record identifier will not be printed immediately after a block identifier!

► Legend of the data blocks

1	Date and time of the printout in UTC time
2	Type of printout: 24h = Daily printout of the driver card !x = Events / faults from the driver card 24hA = Daily printout from the DTCO 1381 !xA = Events / faults from the DTCO 1381 >> = Over-speeding The value set in the speed limiter will also be printed. T = Technical data ! = Driver's activities !v = v-diagram Optional printouts: !D = Status D1/D2 diagram * %v = Speed profiles * %n = Rpm profiles *

3	Information about the cardholder of the inserted tachograph card: □ = Controller □ = Driver □ = Company † = Workshop / inspection centre <ul style="list-style-type: none"> • Last name • First name • Card identification • Card valid until ... If tachograph cards are not associated with a person, the name of the control body, the company, or the workshop will be printed instead of the person's name.
3a	Information about the cardholder of the other tachograph card
4	Vehicle identification: <ul style="list-style-type: none"> • Vehicle identification number • Authorising member state and vehicle registration number
5	Identification of the tachograph: <ul style="list-style-type: none"> • Tachograph manufacturer • Part number of the DTCO 1381 tachograph



6	<p>Most recent tachograph calibration:</p> <ul style="list-style-type: none"> • Name of workshop • Workshop identification • Date of calibration 	8b	<p>Insertion of driver card into slot (card slot 1 or card slot 2):</p> <ul style="list-style-type: none"> • Authorising member state and vehicle registration number • Odometer reading when card inserted 	8h	<p>The specific condition "OUT of scope" was switched on at start of the day.</p>
7	<p>Most recent control:</p> <ul style="list-style-type: none"> • Control card identification • Date, time, and type of control <p>  = Downloading from the driver card  = Downloading from the DTCO 1381  = Printing  = Displaying </p>	8c	<p>Activities of the driver card:</p> <ul style="list-style-type: none"> • Beginning and duration, and driving status  = Crew operation 	9	<p>Beginning of list of all driver activities in the DTCO 1381:</p> <ul style="list-style-type: none"> • Calendar day of printout • Odometer readings at the times 00:00 and 23:59
8	<p>List of all driver activities in the order they appear:</p> <ul style="list-style-type: none"> • Calendar day of the printout and the usage counter (number of days that the card was used.) 	8d	<p>Specific conditions:</p> <ul style="list-style-type: none"> • Time of entry and pictogram, for example: ferry or train 	10	<p>Chronology of all activities from card slot 1</p>
8a	<p>? = Time period that the card was not inserted:</p> <ul style="list-style-type: none"> • Manually entered activity after insertion of the driver card, with pictogram, beginning and duration. 	8e	<p>Withdrawal of driver card:</p> <ul style="list-style-type: none"> • Odometer reading and distance travelled since most recent insertion 	10a	<p>Time period in which no driver card was inserted in card slot 1:</p> <ul style="list-style-type: none"> • Odometer reading at the beginning of the time period • Set activity or activities in this time period • Odometer reading at the end of the time period and distance traveled
		8f	<p>Attention: Possible inconsistency in the data recording since this day was saved twice on the tachograph card.</p>	10b	<p>Insertion of the driver card:</p> <ul style="list-style-type: none"> • Last name of driver • First name of driver • Card identification • Card valid until ...
		8g	<p>Activity not completed:</p> <ul style="list-style-type: none"> • Duration of activity and daily summaries might be given incompletely when printouts are made while the driver card is inserted. 		

10c	<ul style="list-style-type: none"> Authorising member state and vehicle registration number of the previous vehicle Date and time card was removed from the previous vehicle
10d	<ul style="list-style-type: none"> Odometer reading when driver card inserted M = the entry was done manually
10e	<p>List of activities:</p> <ul style="list-style-type: none"> Pictogram of the activity, beginning and duration, and driving status ☐☐ = Crew operation
10f	<p>Entry of specific conditions:</p> <ul style="list-style-type: none"> Entry time and pictogram of the condition ⚓ = Ferry transfer or train transfer ☐☐T+ = Begin (Recording equipment not required) +☐☐T = End
10g	<p>Withdrawal of driver card:</p> <ul style="list-style-type: none"> Odometer reading and distance travelled
10h	<p>Chronology of all activities from card slot 2</p>

10i	<p>The specific condition "OUT of scope" was switched on at start of the day.</p>
11	<p>Daily summary</p>
11a	<p>Entered locations:</p> <ul style="list-style-type: none"> ⚓+ = Beginning time with country and region (if applicable) +⚓ = Ending time with country and possibly region Vehicle odometer reading
11b	<p>Summary of times with no driver card in card slot 1:</p> <ul style="list-style-type: none"> Entered locations in chronological order (no entry in example) Total activities from card slot 1
11c	<p>Summary of times with "no driver card" in card slot 2:</p> <ul style="list-style-type: none"> Entered locations in chronological order (no entry in example) Total activities from card slot 2

11d	<p>Daily summary "Total values of activities" from the driver card:</p> <ul style="list-style-type: none"> Total driving time and distance travelled Total work and availability time Total rest time and unknown time Total time in crew activities
11e	<p>Summary of the activities, chronologically arranged by driver (cumulative for each driver for both card slots):</p> <ul style="list-style-type: none"> Last name, first name, card identification of the driver ⚓+ = Beginning time with country and region (if applicable) +⚓ = Ending time with country and possibly region Activities from this driver with: Total driving time and distance travelled, total work and total availability time, total rest time, total time in crew activities.
12	<p>List of the five most recent saved events or faults on the driver card. ⇨⇨</p>





12a	List of all saved events on the driver card, arranged according to type of fault and date.	13b	List of all recorded or continuing faults of the DTCO 1381.		<p><i>Line 3:</i></p> <ul style="list-style-type: none"> • Identification of the driver card(s) (maximum of four entries) that was inserted at the beginning or at the end of the event or fault. • "▣----" appears when no driver card is inserted.
12b	List of all saved faults on the driver card, arranged according to type of fault and date.	13c	Data record of the event or fault. <i>Line 1:</i>	14	Identification of the tachograph: <ul style="list-style-type: none"> • Tachograph manufacturer • Address of the tachograph manufacturer • Part number • Type approval number • Series number • Year of manufacture • Version and date of installation of the user software
12c	Data record of the event or fault. <i>Line 1:</i> <ul style="list-style-type: none"> • Pictogram of the event or fault • Date and beginning <i>Line 2:</i> <ul style="list-style-type: none"> • Events subject to security breach are broken down with an additional code. <ul style="list-style-type: none"> ➔ Refer to "Data record purpose during events or faults" on page 105. • Duration of the event or fault <i>Line 3:</i> <ul style="list-style-type: none"> • Authorising member state and vehicle registration number of the vehicle in which the events or faults appeared. 		<i>Line 1:</i> <ul style="list-style-type: none"> • Pictogram of the event or fault • Coding of data record purpose. <ul style="list-style-type: none"> ➔ Refer to "Data record purpose during events or faults" on page 105. • Date and beginning <i>Line 2:</i> <ul style="list-style-type: none"> • Events subject to security breach are broken down with an additional code. <ul style="list-style-type: none"> ➔ Refer to "Coding for more detailed description" on page 107. • Number of similar events on this day. <ul style="list-style-type: none"> ➔ Refer to "Number of similar events" on page 106. • Duration of the event or fault 	15	Identification of the sensor: <ul style="list-style-type: none"> • Series number • Type approval number • Date of initial installation (first pairing with a DTCO 1381)
13	List of the five most recent saved or still active events / faults in the DTCO 1381.			16	Calibration data
13a	List of all recorded or continuing events of the DTCO 1381.				

16a	<p>Listing of the calibration data (in data records):</p> <ul style="list-style-type: none"> Name and address of the workshop Workshop identification Workshop card valid until ...
16b	<ul style="list-style-type: none"> Date and purpose of the calibration: <ul style="list-style-type: none"> 1 = Activation; Recording of known calibration data at the time of activation 2 = Initial installation; first calibration data after activation of the DTCO 1381 3 = Installation after repair - replacement unit; first calibration data in current vehicle 4 = Periodic inspection; calibration data of a periodic inspection 5 = Entry of the vehicle registration number by the company Vehicle identification number Authorising member state and vehicle registration number Authorising member state and vehicle registration number

17	<ul style="list-style-type: none"> Ⓜ = Characteristic coefficient of the vehicle k = Set constant in the DTCO 1381 for the speed adjustment l = Actual circumference of tyre Ⓢ = Tyre size ➤ = Speed limiter setting Old and new odometer reading
17a	<p>Time settings</p> <p>Listing of all available data about time setting: (in data records)</p> <ul style="list-style-type: none"> Date and time, old Date and time, changed Name of workshop that set the time Address of workshop Workshop identification Workshop card valid until ... <p>Note: In the second data record it can be seen that the UTC time was corrected by an authorised workshop.</p>

18	<p>The most recently recorded event and the current fault:</p> <ul style="list-style-type: none"> ! = Most recent event, date, and time ✕ = Most recent fault, date, and time
19	<p>Information on "over-speeding" control:</p> <ul style="list-style-type: none"> Date and time of the most recent control Date and time of the first instance of over-speeding since the most recent control and the number of subsequent over-speeding instances.
20	<p>First instance of over-speeding since the most recent calibration.</p>
20a	<p>The five most severe instances of over-speeding of the last 365 days.</p>
20b	<p>The 10 most recently recorded instances of over-speeding. For each day the most severe instance of over-speeding is recorded.</p>



20c	<p>Entries during instances of over-speeding (chronologically arranged by highest average speed):</p> <ul style="list-style-type: none"> • Date, time, and duration of over-speeding • Highest and average speed of the over-speeding instance, number of similar events on this day 	22	<p>Information about the cardholder of the recorded profile:</p> <ul style="list-style-type: none"> • Last name of driver • First name of driver • Card identification <p>Note: Missing information about the cardholder means: no driver card inserted in card slot 1.</p> <ul style="list-style-type: none"> • Beginning of the profile recording with date and time • End of the profile recording with date and time <p>New profiles are created:</p> <ul style="list-style-type: none"> • by inserting / withdrawing a tachograph card into / from card slot 1 • by a day change • by a correction of the UTC time • by a voltage interruption 	23	<p>Recording of speed profiles:</p> <ul style="list-style-type: none"> • List of the defined speed ranges and period in this range • Range: $0 \leq v < 1 =$ Vehicle stationary <p>The speed profile is divided into 16 zones. During installation, the individual ranges can be adjusted individually.</p>
20c	<ul style="list-style-type: none"> • Last name of driver • First name of driver • Card identification of the driver <p>Note: If no data record for an instance of over-speeding appears in a block, then the following appears: "→----".</p>	24	<p>Recording of rpm profiles:</p> <ul style="list-style-type: none"> • List of the defined motor rpm ranges and period in this range • Range: $0 \leq n < 1 =$ Engine off • Range: $3281 \leq n < x =$ unlimited <p>The rpm profile is divided into 16 zones. During installation, the individual ranges can be adjusted individually.</p>		
21	<p>Handwritten information:</p> <ul style="list-style-type: none"> •  = Location of control •  = Signature of the controller •  = Start time •  = End time •  = Signature of the driver 	25	<p>Manufacturer-specific data:</p> <ul style="list-style-type: none"> • Version number of the software upgrade module (SWUM) 		

<p>26</p>	<p>Configuration of the "independent motion signal"</p> <ul style="list-style-type: none"> • CAN: Vehicle data bus 1 or 2 • Source: Signal source; • speed = ABS / wheel = wheel speed / odometer (GPS) = GPS unitt • Gain: Conversion factor for adapting the unit of measurement between "independent signal source" and sensor signal. • Factor: Factor for adaptation to the sensor signal. 	<p>28</p> <p>Recording of the activities:</p> <ul style="list-style-type: none"> • Legend of the symbols • From the selected day on, there are profiles of the activities of the last 7 calendar days. 	<p>32</p> <p>Period of the printout in local time:</p> <ul style="list-style-type: none"> • ☉+ = Start of recording • +☉ = End of recording • UTC +01h00 = Difference between UTC time and local time.
<p>27</p>	<p>Information on the installed sensor (from Release 2.1):</p> <ul style="list-style-type: none"> • OK: The installed sensor (KTAS2+) meets the requirement 161a (CR (EU) No. 1266/2009). • ? : The sensor must be checked by an authorised workshop. 	<p>29</p> <p>Recording of the speed data on the selected day.</p>	<p>33</p> <p>Date and time of the printout in local time (LOC).</p>
		<p>30</p> <p>Recording of additional statuses, such as the use of blue lights and sirens on emergency vehicles, etc.:</p> <ul style="list-style-type: none"> • Legend of the symbols • From the selected day on, there are profiles of status inputs D1/D2 of the last 7 calendar days. 	<p>34</p> <p>Type of printout e.g. "24h☐☐" in local time "☐".</p>
		<p>31</p> <p>Please note: Not a legal printout!</p> <p>A printout in local time can not be used for legal purposes and is not in accordance with the relevant Regulations (e.g. retention requirements)!</p>	

■ Data record purpose during events or faults

For each established event or each established fault, the DTCO 1381 will register and save the data according to the specified rules.

	⊗F /12345678901234 5 6
	⊗B /22335578901234 1 2
1	→→ 4 15.10.2013 11:10 (45) 00h30
	⊗DK /45670901234567 7 8
2	⊗F /12345678901234 5 6

(1) Data record purpose

(2) Number of similar events on this day

The data record purpose (1) indicates why the event or fault was recorded. Events of the same type appearing several times on this day are displayed at pos. (2).

► Coding of data record purpose

The following overview shows the events and faults arranged according to error type (cause) and the assignment of the data record purpose:

Events	
Picto / reason	Purpose
!⊗⊗ Cards conflict ²⁾	0
!⊗⊗ Driving without valid card ²⁾	1 / 2 / 7
!⊗⊗ Insertion while driving	3
!⊗⊗ Card not closed	0
→→ Over-speeding ²⁾	4 / 5 / 6
!⊕ Power interruption	1 / 2 / 7
!⊗⊗ Sensor fault	1 / 2 / 7
!⊗⊗ Motion conflict ²⁾	1 / 2
!⊗ Security breach	0
!⊗⊗ Time overlap ¹⁾	–
!⊗ Card invalid ³⁾	–

Faults

Picto / reason	Purpose
⊗⊗ Card fault	0
⊗⊗ Internal fault	0 / 6
⊗⊗ Printer fault	0 / 6
⊗⊗ Display fault	0 / 6
⊗⊗ Download fault	0 / 6
⊗⊗ Independent motion signal missing ²⁾ (IMS = Independent Motion Signal)	0 / 6

1) This event will be saved only on the driver card.

2) This event / fault will only be saved in the DTCO 1381.

3) The DTCO 1381 will not save this event.

Overview Data record purpose

- 0 = One of the 10 most recent (or last) events or faults.
- 1 = The longest event for one of the last 10 days of occurrence.
- 2 = One of the 5 longest events over the last 365 days.
- 3 = The last event for one of the last 10 days of occurrence.
- 4 = The most serious event for one of the last 10 days of occurrence.
- 5 = One of the 5 most serious events over the last 365 days.
- 6 = The first event or fault having occurred after the last calibration.
- 7 = An active / on-going event or fault.

Number of similar events

- 0 = For this event, it is not necessary to save "Number of similar events".
- 1 = One event of this type appeared on this day.
- 2 = Two events of this type appeared on this day, but only one was saved.
- n = "n" events of this type appeared on this day, but only one was saved.

► Coding for more detailed description

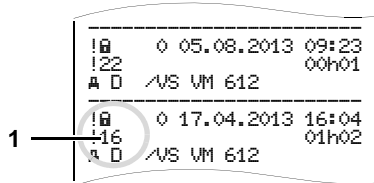

Events subject to security breach "!" are broken down with an additional coding (1).

Security Breach Codes relating to the DTCO 1381

- 10 = No additional information
- 11 = Failed authentication of the sensor
- 12 = Authentication errors of the driver card
- 13 = Unauthorised changes to the sensor
- 14 = Integrity error, the authenticity of the data on the driver card is not assured.
- 15 = Integrity error, the authenticity of the saved user data is not assured.

- 16 = Internal data transmission error
- 17 = Unauthorised opening of the casing
- 18 = Manipulation of the hardware

Security Breach Codes relating to the impulse sensor

- 20 = No additional information
- 21 = Failed authentication
- 22 = Integrity error, the authenticity of the memory data is not assured.
- 23 = Internal data transmission error
- 24 = Unauthorized opening of the casing
- 25 = Manipulation of the hardware

Service only

■ Keyword directory

A		D	
ADR variant	15	Danger of explosion	9, 25, 37
Functional deviations	16	Danger of injury	44
Symbol on the device	15	Data download	25
C		Data transfer	25
Care and maintenance	83	Download key	25
Cleaning the DTCO 1381	83	Software	25
Compulsory tachograph inspections	83	Default display	18
Repair / Replacement	83	Definitions	8
Clear paper jam	46	Driver 1	8
Company card	79	Driver 2	8
Company card insertion	23	Display company	64
Company card withdrawal	26	Display instrument	67
Data on the company card	81	Display variations	17
Enter vehicle registration number	24	Data display when the vehicle is	
Functions of the company card	22	stationary	18
Menu functions in		Default display	18
the "company" mode	22	Display after ignition on	17
Company Lock-out	26	Display of messages	19
Country symbols	89	Ferry transfer or train transfer	19
Symbols of the regions	90	Low voltage / overvoltage	20
		Out of scope	19
		Production status	19
		Standby mode	17
		VDO GeoLoc * (from Release 2.1) ...	17
		Disposal	83
		Download interface	16
		Connection to download interface ...	25
		Downloading driver card data	37
		Connection to download interface ...	37
		Data download	37
		Data transfer	37
		Download key	37
		Driver / vehicle change	41
		Documents to be kept while driving ...	42
		Mixed operation	41
		Driver card	79
		Data on the driver card	81
		Inserting driver card	28
		Withdrawing driver card	38
		Driving time warnings	72
		E	
		End of paper	46
		Enter vehicle registration number	24
		Entry	60
		Enter Begin country	60
		Enter Beginning of ferry / train	61
		Enter End country	60

Enter Out beginning / end 61
 Make UTC correction 62
 Set Local time 61
 Events 68

F
 Faults 70

G
 General instructions 7
 Danger of explosion 9
 Danger of injury 9
 Handling the DTCO 1381 9
 Handling the tachograph cards 12
 Legal requirements 10
 Means of depiction 8
 Risk of Accident 9

I
 Insert paper roll 44

L
 Legal requirements 10
 Handling of the printouts 11
 Obligations of the company 11
 Obligations of the driver 10
 Low voltage / overvoltage 20

M
 Manual entries 28
 Aborting the entry procedure 31
 Add "Rest period" activity 32
 Continuing the work shift 33
 Correction possibilities 30
 Country entry 31
 Fundamental course of action 29
 Not adding activities 29
 Prefixing activity to a shift 34
 Menu functions 47
 Calling up menu functions 48
 Data access blocked 56
 Display driver 1 / driver 2 63
 Display vehicle 64
 Displaying the times of
 the driver card 49
 Entry vehicle 61
 Leaving menu functions 56
 Menu access blocked 56
 Menu entry driver 1 / driver 2 60
 Navigating in the menu functions 55
 Printout driver 1 / driver 2 57
 Printout vehicle 58
 Setting the language 49
 When the vehicle is stationary 48
 Menu guidance after withdrawing
 driver card 39

Menu structure 54
 Messages 65
 A message appears 66
 Acknowledgement of messages 67
 Model plate 16
O
 Operating modes 78
 "Company" mode 21
 Operational mode 27
 Operating steps (first) 14
 For the company 14
 For the driver 14
 Operational elements 15
 Card slot 1 15
 Card slot 2 16
 Cutting edge 16
 Display 15
 Download interface 16
 Driver 1 keypad 15
 Driver 2 keypad 16
 Menu buttons 16
 Unlock button 16
 Operational notes 73

P		
Pictogram combinations	87	
Pictograms	86	
Power interruption	20	
Print activities	57	
Print D1/D2 status input	59	
Print daily value from the data memory	58	
Print daily value from the driver card ...	57	
Print events from the data memory	58	
Print events from the driver card	57	
Print instances of over-speeding	58	
Print rpm profiles	59	
Print speed profiles	59	
Print technical data	58	
Print v-diagram	59	
Printout examples	91	
Activities from the driver card	91	
Daily printout of the vehicle	93	
Driver's activities	96	
Events / faults from the driver card ..	92	
Events / faults from the vehicle	94	
Explanations	98	
Over-speeding	95	
Printout in local time	97	
Rpm profile	97	
Speed profile	97	
Status D1/D2 diagram	96	
Technical data	95	
v-diagram	96	
Printout in local time	39	
Printout of data	45	
Cancel printout	45	
Start printout	45	
Things to note when printing	46	
R		
Register company	23	
Risk of Accident	66	
S		
Setting activities	35	
Automatic setting	35	
Automatic setting after ignition on/off	35	
Handwritten activity entries	36	
Manual setting	35	
Setting the language	49	
T		
Tachograph cards	79	
Access rights of the tachograph cards	80	
Automatic ejection	79	
Cleaning tachograph cards	12	
Company card	79	
Control card	79	
Driver card	79	
Handling the tachograph cards	12	
Locking the tachograph cards	79	
Workshop card	79	
Technical data	84	
DTCO 1381	84	
Paper roll	84	
Time management	82	
U		
UTC time		
Converting to UTC time	82	
V		
VDO Counter *	50	
Daily value	53	
Display for activity "Break time"	52	
Display for activity "Working time" ...	52	
Displays during trip	51	
Layout of the VDO Counter display ..	50	
Status display	53	
Weekly value	53	
VDO GeoLoc * (from Release 2.1)..	17, 81	

■ Automatic setting of the activities after ignition on/off

Automatically set activity ...	
... after ignition on	
<input type="checkbox"/> H	Break time / rest period
<input type="checkbox"/> ✖	Other working time
<input type="checkbox"/> ☑	Availability time
<input type="checkbox"/> -	No change
Driver 1	
... after ignition off	
<input type="checkbox"/> H	Break time / rest period
<input type="checkbox"/> ✖	Other working time
<input type="checkbox"/> ☑	Availability time
<input type="checkbox"/> -	No change
Driver 1	
... after ignition on	
<input type="checkbox"/> H	Break time / rest period
<input type="checkbox"/> ✖	Other working time
<input type="checkbox"/> ☑	Availability time
<input type="checkbox"/> -	No change
Driver 2	
... after ignition off	
<input type="checkbox"/> H	Break time / rest period
<input type="checkbox"/> ✖	Other working time
<input type="checkbox"/> ☑	Availability time
<input type="checkbox"/> -	No change
Driver 2	

Important!

The vehicle manufacturer may have already programmed defined settings of the activity after ignition on/off!

Please mark the set functions in the table by "✓".

 During the "Manual input" (addition of activities on the driver card) this option is disabled! There is no change of activity after ignition on/off!

then the previous display will appear again.

➤ For details on the standard setting, see "Setting activities" as of page 35.

Information about the DTCO 1381

Type:

No:

Year:

Settingdate: _____

Signature: _____

A The automatic setting after ignition on/off is only visible in the standard display (a). The activity flashes for approx. 5 seconds,

■ **Notes**

Service only

A

Service only



Interior

EG-Konformitätserklärung nach Richtlinie Nr. 94/9/EG (ATEX) EC Declaration of Conformity under the terms of Directive No. 94/9/EC (ATEX)

Nr.: HOM_001

Wir erklären hiermit als Hersteller, dass die nachstehend beschriebene Einrichtung die Anforderungen der Richtlinie Nr. 1994/9/EG vom 23. März 1994 für Geräte und Schutzsysteme zur bestimmungsgemäßen Verwendung in explosionsgefährdeten Bereichen erfüllt.
We as manufacturer hereby declare that the following described equipment complies with the fundamental requirements of the Directive No. 94/9/EC of 23 March 1994 concerning equipment and protective systems intended for use in potentially explosive atmospheres.

Hersteller
Manufacturer Continental Automotive GmbH
Heinrich-Hertz-Str. 45, 78052 Villingen-Schwenningen

Gerät
Equipment Digitaler Tachograph Typ DTCO 1381.x
Digital tachograph type DTCO 1381.x

EG-Baumusterprüfbescheinigung
EC type examination certificate TÜV 03 ATEX 2324 X

Benannte Stelle
Notified body TÜV NORD CERT GmbH, Geschäftsstelle Hannover, Am TÜV 1,
30519 Hannover, CE 0044

Gerätekenzeichnung
Marking of the equipment  IIB(2)G Ex nA [ib] IIC T6

Verwendete harmonisierte Normen
Used harmonized standards EN 60079-0: 2006
EN 60079-11: 2007
EN 60079-15: 2005

Andere angewandte Richtlinien VO (EWG) Nr. 3821/85, ECE R10, RL 72/245/EWG

Other used directives

VS-Villingen, den / the 2012-02-08
Continental Automotive GmbH

Winfried Rogenz
Head of Homologation
Name / Name
Funktion / function

Unterschrift
signature

Dr. Harald Jordan
Head TTS Product and Project Quality
Name / Name
Funktion / function

Unterschrift
signature

Diese Erklärung bescheinigt die Übereinstimmung mit den genannten Richtlinien, ist jedoch keine Beschaffenheits- oder Haltbarkeitsgarantie nach §443 BGB. Die
Sicherheitsweise der mitgelieferten Produktdokumentation sind zu beachten.
This declaration certifies the conformity to the specified directives but does not imply any warranty for properties. The safety documentation accompanying the
product shall be considered in detail.

Continental Automotive GmbH
Welfenring 172-2, 67474
78052 Villingen-Schwenningen

Telefon +49 (7721) 67-0
Telefax +49 (7721) 67-47
www.continental-automotive.com

Sitz der Gesellschaft: Hannover
Hans-Bredow-Platz 1
30165 Hannover, Hannover,
USt-Id. Nr. DE314905653

Geschäftsführer:
Harald Jordan
Harald Jordan
Harald Jordan

Continental Automotive GmbH

P.O. Box 1640

78006 Villingen-Schwenningen

GERMANY

www.dtco.vdo.com

A2C86196400

40619648 OPM 000 AB

BA00.1381.21 100 102

Language: English

Printed in Germany | © 04.2013 | Continental Automotive GmbH



VDO